

optiMist
evaporative cooling

CAREL



ENG User manual

➔ **READ AND SAVE
THESE INSTRUCTIONS** ←

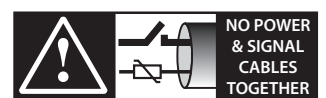

READ CAREFULLY IN THE TEXT!

 GENERAL WARNINGS

The CAREL Industries humidifiers are advanced products, whose operation is specified in the technical documentation supplied with the product or can be downloaded, even prior to purchase, from the website www.carel.com. Each CAREL Industries product, in relation to its advanced level of technology, requires setup/configuration/programming/commissioning to be able to operate in the best possible way for the specific application. The failure to complete such operations, which are required/indicated in the user manual, may cause the final product to malfunction; CAREL Industries accepts no liability in such cases. The customer (manufacturer, developer or installer of the final equipment) accepts all liability and risk relating to the configuration of the product in order to reach the expected results in relation to the specific final installation and/or equipment. CAREL Industries may, based on specific agreements, acts as a consultant for the installation/commissioning/use of the unit, however in no case does it accept liability for the correct operation of the humidifier and the final installation if the warnings or suggestions provided in this manual or in other product technical documents are not heeded. In addition to observing the above warnings and suggestions, the following warnings must be followed for the correct use of the product:

- **DANGER OF ELECTRIC SHOCK** : The humidifier contains live electrical components. Disconnect the power supply before accessing inside parts or during maintenance and installation.
- **DANGER OF WATER LEAKS**: The humidifier automatically and constantly fills/drains certain quantities of water. Malfunctions in the connections or in the humidifier may cause leaks.

 IMPORTANT

- The installation of the product must include an earth connection, using the special yellow-green terminal available in the humidifier.
- The environmental and power supply conditions must conform to the values specified on the product rating labels.
- The product is designed exclusively to humidify rooms either directly or through distribution systems (ducts).
- Only qualified personnel who are aware of the necessary precautions and able to perform the required operations correctly may install, operate or carry out technical service on the product.
- Only water with the characteristics indicated in this manual must be used.
- All operations on the product must be carried out according to the instructions provided in this manual and on the labels applied to the product. Any uses or modifications that are not authorized by the manufacturer are considered improper. CAREL Industries declines all liability for any such unauthorized use.
- Do not attempt to open the humidifier in ways other than those specified in the manual.
- Observe the standards in force in the place where the humidifier is installed.
- Keep the humidifier out of the reach of children and animals.
- Do not install and use the product near objects that may be damaged when in contact with water (or condensate). CAREL Industries declines all liability for direct or indirect damage following water leaks from the humidifier.
- Do not use corrosive chemicals, solvents or aggressive detergents to clean the inside and outside parts of the humidifier, unless specifically indicated in the user manual.
- Do not drop, hit or shake the humidifier, as the inside parts and the linings may be irreparably damaged.

CAREL Industries adopts a policy of continual development. Consequently, CAREL reserves the right to make changes and improvements to any product described in this document without prior warning. The technical specifications shown in the manual may be changed without prior warning. The liability of CAREL Industries in relation to its products is specified in the CAREL Industries general contract conditions, available on the website www.carel.com and/or by specific agreements with customers; specifically, to the extent where allowed by applicable legislation, in no case will CAREL Industries, its employees or subsidiaries be liable for any lost earnings or sales, losses of data and information, costs of replacement goods or services, damage to things or people, downtime or any direct, indirect, incidental, actual, punitive, exemplary, special or consequential damage of any kind whatsoever, whether contractual, extra-contractual or due to negligence, or any other liabilities deriving from the installation, use or impossibility to use the product, even if CAREL Industries or its subsidiaries are warned of the possibility of such damage.

DISPOSAL: INFORMATION FOR USERS



Fig.1



Fig.2

Please read and keep.

With reference to European Union directive 2012/19/EU issued on 4 July 2012 and related national legislation, please note that:

1. Waste Electrical and Electronic Equipment (WEEE) cannot be disposed of as municipal waste but must be collected separately so as to allow subsequent recycling, treatment or disposal, as required by law;
2. users are required to take Electrical and Electronic Equipment (EEE) at end-of-life, complete with all essential components, to the WEEE collection centres identified by local authorities. The directive also provides for the possibility to return the equipment to the distributor or retailer at end-of-life if purchasing equivalent new equipment, on a one-to-one basis, or one-to-zero for equipment less than 25 cm on their longest side;
3. this equipment may contain hazardous substances: improper use or incorrect disposal of such may have negative effects on human health and on the environment;
4. the symbol (crossed-out wheeled bin – Fig.1) even if, shown on the product or on the packaging, indicates that the equipment must be disposed of separately at end-of-life;
5. if at end-of-life the EEE contains a battery (Fig. 2), this must be removed following the instructions provided in the user manual before disposing of the equipment. Used batteries must be taken to appropriate waste collection centres as required by local regulations;
6. in the event of illegal disposal of electrical and electronic waste, the penalties are specified by local waste disposal legislation.

Warranty on the materials: 2 years (from the date of production, excluding consumables).

Approval: the quality and safety of CAREL INDUSTRIES Hqs products are guaranteed by the ISO 9001 certified design and production system and  ..



WARNING

Separate as much as possible the probe and digital input signal cables from the cables carrying inductive loads and power cables to avoid possible electromagnetic disturbance. Never run power cables (including the electrical panel wiring) and signal cables in the same conduits.

Content

1.	INTRODUCTION AND MOUNTING	7	8.	STARTING AND USER INTERFACE	29
1.1	optiMist description	7	8.1	Starting	29
1.2	Components of the system	7	8.2	Stopping	29
1.3	Configuration of the optiMist system.....	7	8.3	First start-up (setting the language).....	29
1.4	Dimensions and weights.....	8	8.4	Wizard	29
1.5	Components	9	8.5	Keypad	29
1.6	Electrical specifications	10	8.6	"Main" screen	29
1.7	Opening the packaging.....	10	8.7	"INFO" screens	30
1.8	Positioning the cabinet	10	8.8	"SET" screen	30
1.9	Wall mounting.....	10	8.9	"Warnings" screen	30
1.10	Opening the cabinet door.....	11	8.10	Main menu	30
1.11	Components and accessories.....	11	8.11	User menu	33
2.	WATER CONNECTIONS	12	8.12	Installer menu.....	34
2.1	Supply water characteristics.....	13	8.13	Maintenance menu.....	37
2.2	Type of supply water.....	13	9.	TABLE OF ALARMS	39
2.3	Water circuit installation: checklist	13	10.	WIRING DIAGRAMS	41
3.	ELECTRICAL CONNECTIONS	14	10.1	optiMist wiring diagram.....	41
3.1	Wiring inlets.....	14	10.2	optiMist UL version wiring diagram	42
3.2	Power supply	14	11.	STARTUP	43
3.3	Connections to the pCO.....	14	11.1	Startup.....	43
3.4	Connections to the terminal board.....	14	12.	MAINTENANCE AND REPLACEMENT PARTS	44
3.5	Control signals from external voltage-free contact, humidostat or thermostat type.....	15	12.1	Maintenance procedures	44
3.6	Modulating control signal	16	12.2	Replacement parts	44
3.7	Discharge solenoid valve connection for distribution (optional)	17			
3.8	Water treatment system control	18			
3.9	Cumulative alarm output (J15).....	18			
3.10	Alarm inputs from external devices.....	18			
3.11	Frost protection alarm output.....	18			
3.12	Backup cabinet signal.....	18			
3.13	Supervisor network.....	19			
3.14	Supervisory optiMist Table	19			
4.	PUMPING UNITS	22			
4.1	Pumping unit with flow control configuration	22			
5.	DISTRIBUTION SYSTEM	23			
5.1	Distribution and atomisation rack.....	23			
5.2	Droplet separator	23			
6.	APPLICATIONS	25			
6.1	Main advantages of optiMist	25			
7.	CONTROL	26			
7.1	Humidification.....	26			
7.2	Evaporative Cooling.....	27			
7.3	Humidification + Evaporative Cooling.....	28			

1. INTRODUCTION AND MOUNTING

1.1 optiMist description

optiMist is an evaporative cooler and humidifier that atomises water in fine droplets which then spontaneously evaporate, removing heat from the humidified and cooled air.

optiMist uses a vane pump to pressurise the water, subsequently atomising it through special nozzles.

The sophisticated control system combines the action of an inverter, which regulates the speed and consequently the flow-rate of the pump, with two solenoid valves that activate only the necessary nozzles, allowing the system to always work at the ideal pressure to atomise the water, across a wide range of flow-rates.

The effect of cooling the air is due to the spontaneous evaporation of the droplets of water: the change in state from liquid to vapour occurs by subtracting energy from the air that, as a consequence, is cooled.

Each kilogram of water evaporated absorbs 0.69 kW of heat from the air.

optiMist is a complete evaporative cooling and humidification system that can be used to treat the air in an AHU (air handling units) and to both humidify and to indirectly cool the renewal air, in order to increase the energy efficiency of the AHU.

1.2 Components of the system

optiMist is comprised of

- a pumping station that pressurizes the water (4-15 bar). It also contains the electronic controller that completely manages the pumping station, controlling the temperature/humidity in each section. Since it is equipped with an inverter and pressure sensor, it manages to control the flow of water produced at any moment, thus ensuring maximum precision and minimum energy and water consumption.
- distribution and atomisation system of pipes for transporting the pressurised water, which contain the atomisation nozzles and drain valves;
- droplet separator;
- temperature and/or humidity probes or control through external signal;
- water treatment system: typically this is a reverse osmosis demineraliser that supplies water with a low mineral salt content to the optiMist.

1.3 Configuration of the optiMist system

The optiMist system can be configured to:

1. Control the air humidity, installing a pumping station and a distribution system (with two-step modulation) in the AHU humidification section.

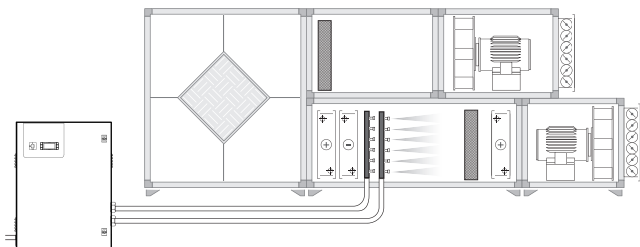

Fig. 1.a

2. Control indirect evaporative cooling (IEC) by installing a pumping station and a distribution system (with two-step modulation) in the upstream section of the AHU heat recovery unit.

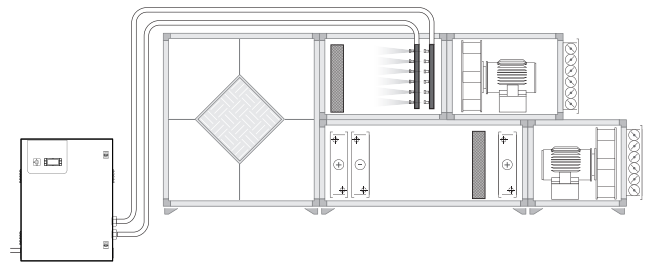

Fig. 1.b

3. Control both humidification and evaporative cooling with a pumping system that will serve the two distribution systems, each with one-step modulation.

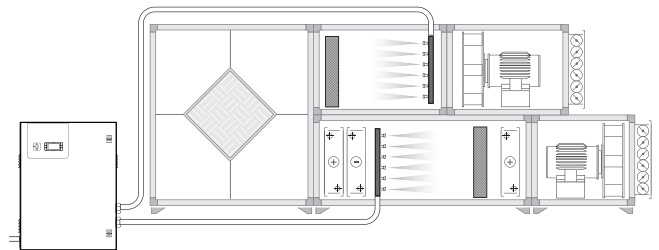

Fig. 1.c

The configuration for indirect evaporative cooling applications is of particular importance. Besides humidification of the air in the winter, optiMist can be used in the summer to cool the discharged air in the summer before it enters a heat recovery unit.

This configuration is explained in the detail in the chapters below.

optiMist humidifiers are available for:

- flow-rates: 50 l/h (EC005...), 100 l/h (EC010...), 200 l/h (EC020...), 400 l/h (EC040...), 800 l/h (EC080...) and 1000 l/h (EC100...);
- power supply voltage: D = 230 V 50 Hz; U = 230 V 60 Hz;

1.4 Dimensions and weights

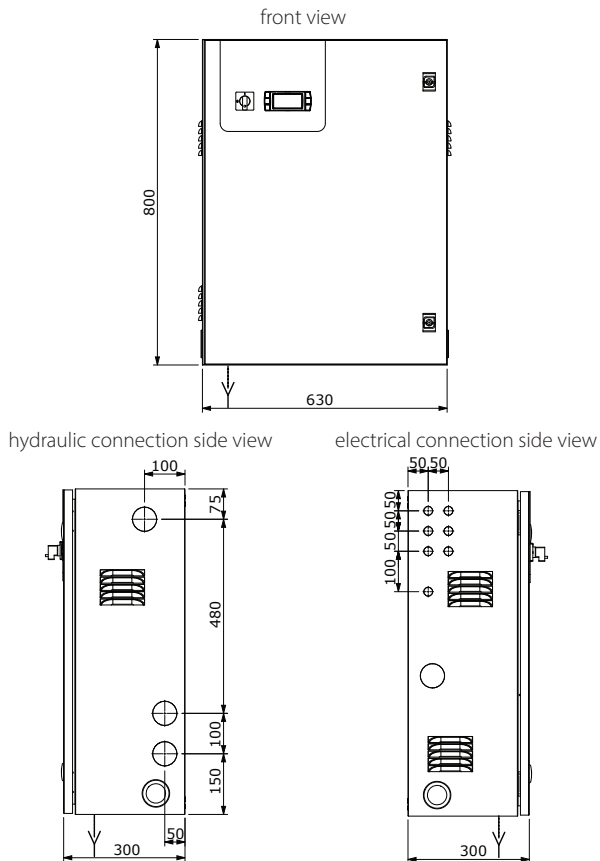

Fig. 1.d

Cabinet dimensions

- Height (H): 800 mm (31.50 inch);
- Width (W): 630 mm (24.80 inch)
- Depth (D): 300 mm (11.82 inch).

Packaging dimensions

- Height (H): 1020 mm (40 inch);
- Width (W): 720 mm (28.5 inch).
- Depth (D): 410 mm (16 inch).

Weight:

- models EC005****: 53 kg (117 lb);
- models EC010****: 53 kg (117 lb);
- models EC020****: 55 kg (121 lb);
- models EC040****: 55 kg (121 lb);
- models EC080****: 59 kg (130 lb);
- models EC100****: 59 kg (130 lb).

Weight with package:

- models EC005****: 56 kg (124 lb);
- models EC010****: 56 kg (124 lb);
- models EC020****: 58 kg (128 lb);
- models EC040****: 58 kg (128 lb);
- models EC080****: 62 kg (137 lb);
- models EC100****: 62 kg (137 lb).

Mechanical characteristics

- Installation: wall-mounted
- IP20
- operating conditions: 5 to 40 °C (34 to 104 °F) <80 % RH non-condensing
- storage conditions: 5 to 50 °C (34 to 122 °F) <80 % RH non-condensing

1.5 Components

Components of the electrical section

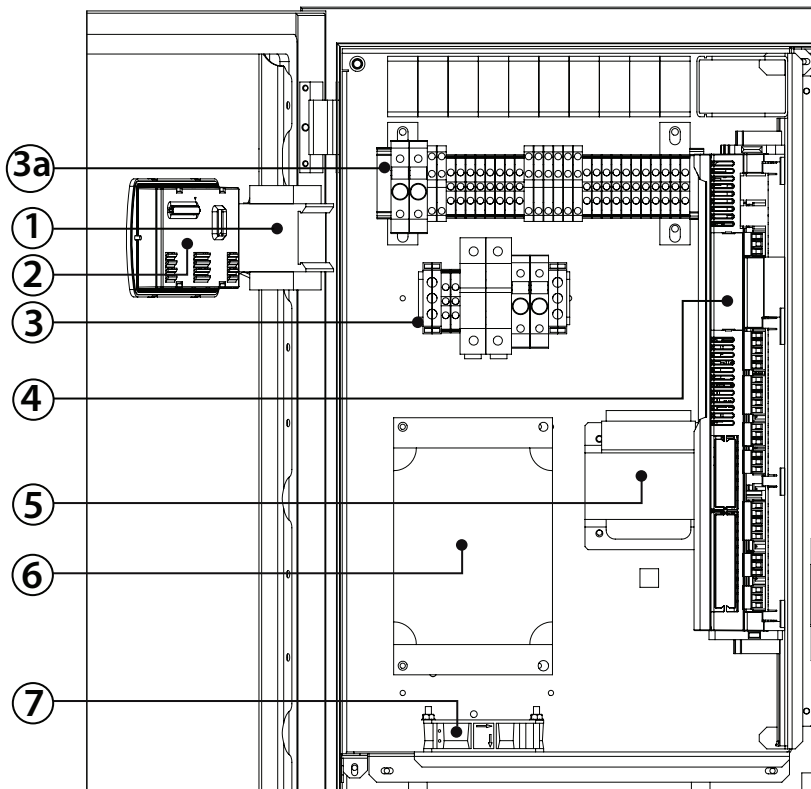

Key:

- 1. Main switch
- 2. Display
- 3. Electrical power terminals
- 3.a External signal terminals
- 4. Electronic controller
- 5. Trasformer
- 6. Inverter
- 7. Fan

Fig. 1.e

Components of the hydraulic section

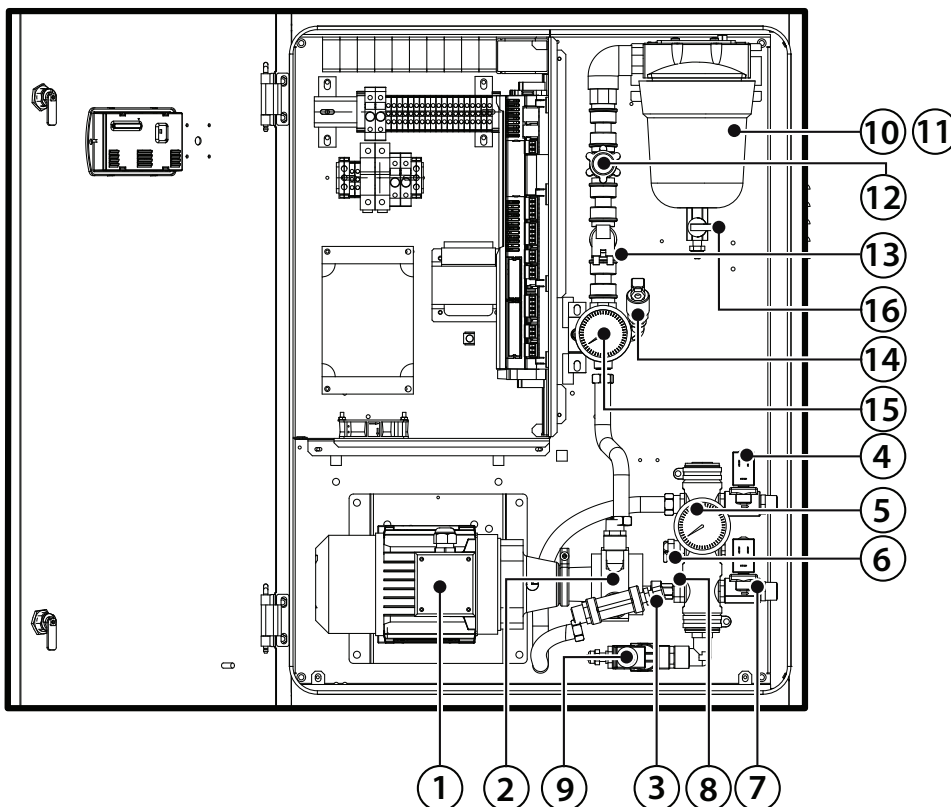

Key:

- 1. Motor
- 2. Pump
- 3. Temperature probe
- 4. Solenoid valve step.1
- 5. Monometer
- 6. Temperature valve
- 7. Solenoid valve step 2
- 8. Pressure probe
- 9. Cabinet drain valve
- 10. Filter case
- 11. Filter cartidge
- 12. Pressure reducer
- 13. Fill solenoid valve
- 14. Pressure switch
- 15. Manometer
- 16. Filter drain

Fig. 1.f

1.6 Electrical specifications

EC*****0 (230 V 50 Hz) Modells

	voltage Vac	phases	frequency Hz	power kW	current A
EC005*****0	230	1	50	0,275	1,2
EC010*****0	230	1	50	0,275	1,5
EC020*****0	230	1	50	0,475	1,6
EC040*****0	230	1	50	0,475	2,3
EC080*****0	230	1	50	0,75	3,0
EC100*****0	230	1	50	0,75	3,2

Tab. 1.a

Product in compliance with EN55014, EN61000, EN60204.
Insulation grade III

Modelli EC*****U (230V 60 Hz)

	voltage Vac	phases	frequ. Hz	power kW	current A	FLA	SCCR
EC005*****U	230	1	60	0,375	1,2	0.35 HP/2A	5 KA
EC010*****U	230	1	60	0,375	1,5	0.35 HP/2A	5 KA
EC020*****U	230	1	60	0,375	1,6	0.5 HP/3.2A	5 KA
EC040*****U	230	1	60	0,375	2,3	0.5 HP/3.2A	5 KA
EC080*****U	230	1	60	0,75	3,0	1 HP/6.0A	5 KA
EC100*****U	230	1	60	0,75	3,2	1 HP/6.0A	5 KA

Tab. 1.b

Product in compliance with UL998

1.7 Opening the packaging



- make sure the humidifier is intact upon delivery and immediately notify the transporter, in writing, of any damage that may be due to careless or improper transport;
- move the humidifier to the site of installation before removing from the packaging, grasping the neck only from underneath the base;
- open the cardboard box, remove the protective material and remove the humidifier, keeping it vertical at all times.

Store the packaging in a dry location (cardboard boxes, pallets, bolts and fillers) so that they may be reused.

- humidity 20-80% RH, non condensing
- temperature 1-40 °C;

1.8 Positioning the cabinet

The humidifier should be positioned so as to guarantee the following:

- open the front panel;
- access to the inside parts for checks and maintenance;
- connection of the water supply lines;
- connection to the water distribution lines;
- power and control connections;

Recommended clearance for routine maintenance:

- from the front 1m;
- right and left sides around 0.3 m.



Important: the maximum horizontal distance between the cabinet and the distribution system/frame is:

1. 10 meters if discharge solenoid valves are used
2. 5 meters if mechanical solenoid valves are used (no mechanical valves with EC005*);
3. for larger distances, contact CAREL INDUSTRIES.

Positioning procedure:

- after opening the packaging;
- position the cabinet in the final position;
- position the cabinet horizontally.

1.9 Wall mounting

Fasten the humidifier to a solid support surface using the screws and bracket supplied.

Make sure there is enough space to connect the air and water inlet and outlet lines.

Drilling for wall mounting

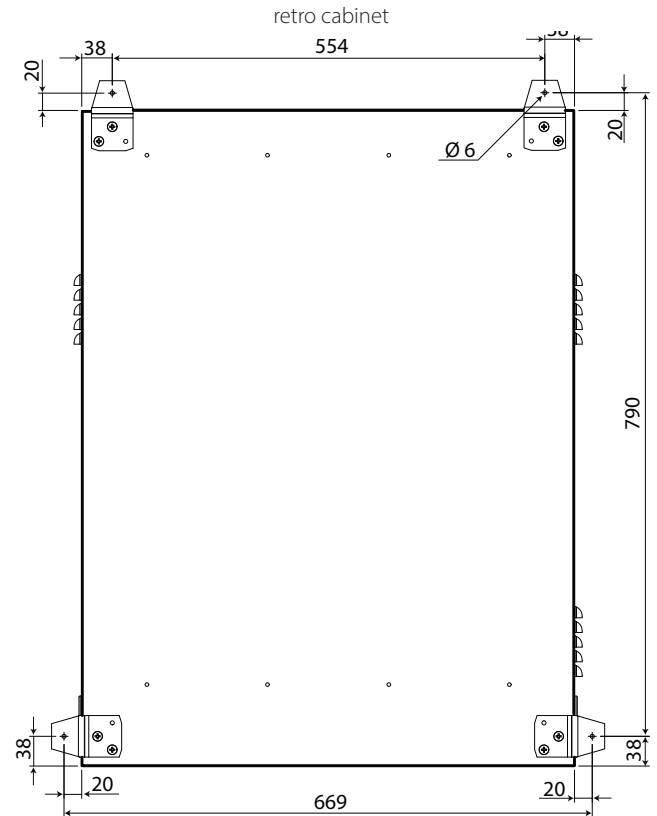

Fig. 1.g

sezione staffe

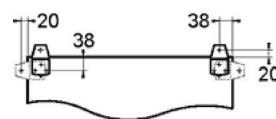

Fig. 1.h

1.10 Opening the cabinet door

1. press and turn anticlockwise using the keys supplied until releasing the door;
2. open the door on the cabinet by swinging it to the right (in the direction of the arrow).

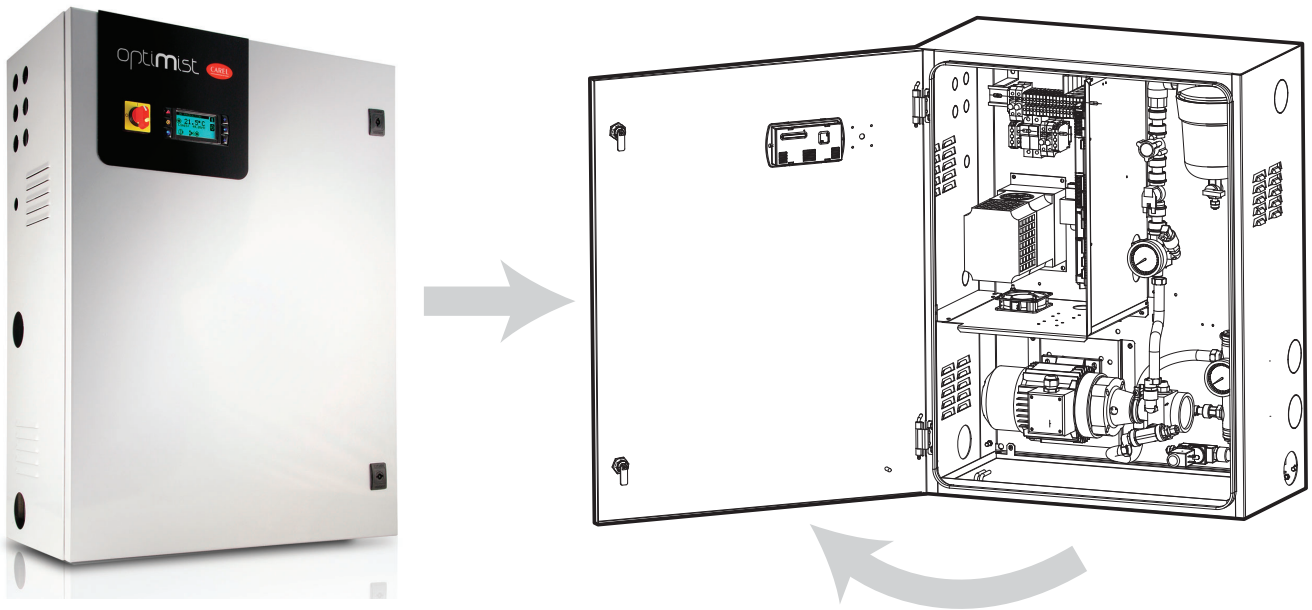

Fig. 1.i

1.11 Components and accessories

Once having opened the packaging, check the following are included:

- opening key;
- kit of screws with plugs for wall-mounting (inside the cabinet);
- cable glands for the electrical connections;
- tool for opening the water filter casing;
- wall fit brackets;
- ferrite (see par. 3.2, Fig. 3.b);
- user manual.

2. WATER CONNECTIONS

Important: before making the connections, make sure that the unit is disconnected from the mains.

CAUTION: for the Australian market and to comply with Watermark requirements, a watermarked approved dual check valve shall be installed in the supply line to the humidifier when connected to potable water. Should on the other hand the humidifier be fed with treated water from a Carel reverse osmosis system connected to potable water, the dual check valve shall be installed in the supply line to the reverse osmosis system.

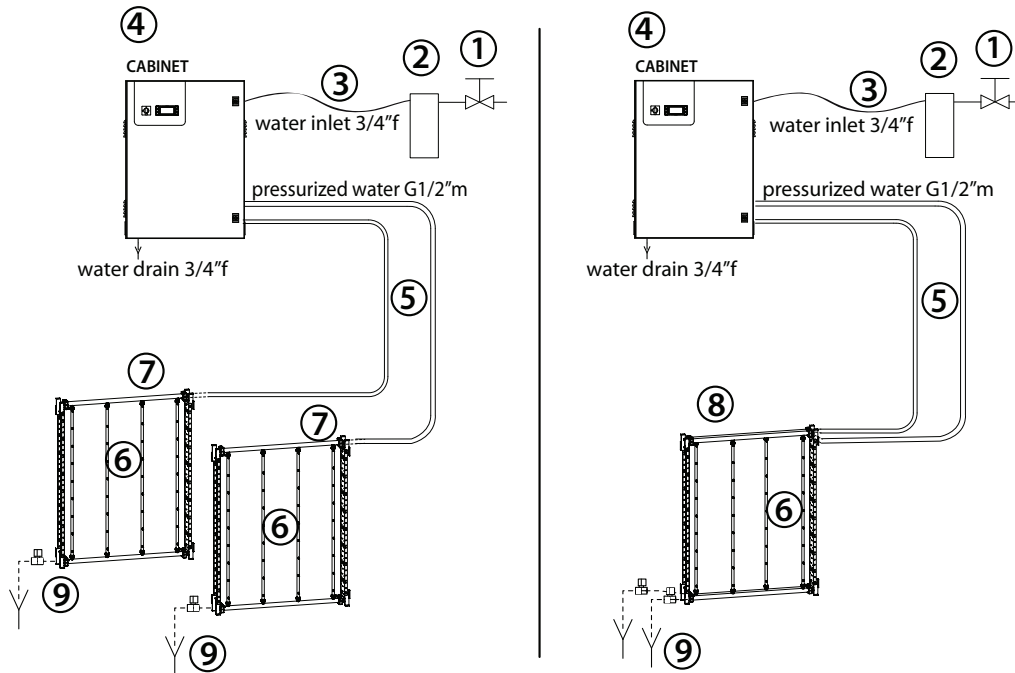

Fig. 2.a

key:

1. install a manual valve upstream of the installation to allow the water line to be isolated (not supplied by CAREL);
2. install a 10 μ water filter (CAREL code ACKF000000 to remove solid particles from the supply water;
3. flexible hose (not supplied by CAREL);
4. optiMist cabinet;
5. hoses complete with adapters;
6. nozzles (see Chap. 4);
7. manifolds;
8. manifold connection hoses;
9. drain valves.

N.B.: for direct connection to the mains water supply use pipes and fittings compliant with IEC 61770.

Connections:

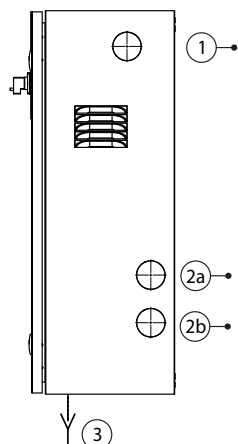

Fig. 2.b

Key:

1. water inlet (G3/4" femmina);
- 2a. pressurised water outlet step 1 (G1/2" male);
- 2b. pressurised water outlet step 2 (G1/2" male);
3. tank-drain water (G3/4" female).



Notes for connection between cabinet and rack:

1. Mount the pipes with u-bolts or clamps with steps of about 30 cm. (not supplied by Carel).
2. In the case of two racks or one two-step rack, mount the pipes parallel, avoiding any contact.
3. In laying the pipes, avoid conditions that could cause the water to stagnate with the system is halted.

Connect an expansion tank (not supplied by CAREL SpA) with a capacity of at least 5 litres, upstream from the cabinet in order to prevent water hammering which can damage the system.

The connection to the cabinet must be performed using flexible piping.

2.1 Supply water characteristics

Water connection characteristics

VERSION CE - Models EC*****0

Model	EC005*0	EC010*0	EC020*0	EC040*0	EC080*0	EC100*0
flow-rate	50	100	200	400	800	1000
Maximum	110	220	440	880	1760	2200
(l/h;lb/h;Gd)	317	634	1268	2536	5072	6340
inlet	(0.2..0.7); (2..7); (29..100).					
(Mpa, Bar, Psi)						
Temperature	5T40 °C / 41T104 °F					
Inlet	G3/4" f					
Outlet 1 and 2 (solenoid)	G1/2" m					
Drain	Stainless steel pipe G3/4f interior, Ø exterior ~35 mm/ 1.18 inch.					

Tab. 2.a

VERSION UL - Models EC*****U

Model	EC005*U	EC010*U	EC020*U	EC040*U	EC080*U	EC100*U
flow-rate	50	100	200	400	800	1000
Maximum	110	220	440	880	1760	2200
(l/h;lb/h;Gd)	317	634	1268	2536	5072	6340
inlet	(0.2..0.7); (2..7); (29..100).					
(Mpa, Bar, Psi)						
Temperature	5T40 °C / 41T104 °F					
Inlet	NPT 3/4" f					
Adapter outlet (pump)	NPT 1/2" f					
Drain	Stainless steel pipe NPT3/4" f interior, Ø exterior ~35 mm/ 1.18 inch.					

Tab. 2.b

2.2 Type of supply water

optiMist can work with:

- demineralised water
- soft water
- tap water

Following the evaporation process, the minerals dissolved in the supply water will be partially transported by the air flow as very fine powder and part of them will be deposited on the surfaces of the separator and the fins of the heat exchanger.

The type and amount of minerals contained in the supply water determine the frequency of regular maintenance operations needed to remove these deposits from inside the AHU.

The main components of the system supplied by Carel which are affected by any incrustations and which require regular periodic inspection and maintenance are the nozzles and droplet separator.

In order to maintain system hygiene and to reduce system management costs, Carel recommends supplying optiMist with water that has been demineralised by reverse osmosis, as provided for in the principal norms such as UNI 8884.

In particular, Norm UNI 8884 "Characteristics and treatment of water for cooling and humidification circuits" suggests that evaporative humidifiers be supplied with fresh water (as indicated in directive 98/83/EC) having the following characteristics:

- electrical conductivity <100 µS/cm;
- total hardness <5 °fH (50 ppm CaCO₃);
- 6.5<pH< 8.5;
- chloride content <20 mg/l;
- silica content <5 mg/l;

Note 1: If demineralised water is not available, softened water may be used. In this case, in order to limit the aggressiveness of softened water, a minimum hardness no less than 3°f should be ensured.

Note 2: Carel recommends using mains water only if it has a hardness of less than 16°f or a conductivity of less than 400µS/cm.

The use of mains water leads to ordinary maintenance operations (nozzle and droplet separator cleaning) whose frequency depends on the chemical composition of the water.

2.3 Water circuit installation: checklist

optiMist system name: _____



Description Notes

- Cabinet level
- Horizontal distance between cabinet-rack/water distribution system: ≤10 m.
- Water supply connection
- Water inlet pressure ≥2 bar (0.2 MPA, 29 PSI)
- Filters filled with water
- Drain connected to the water drain system
- Supply water within the limit values. See section "Supply water characteristics"
- Calibration optional separator differential switch (if present)

Date: _____

Signature: _____

3. ELECTRICAL CONNECTIONS

3.1 Wiring inlets

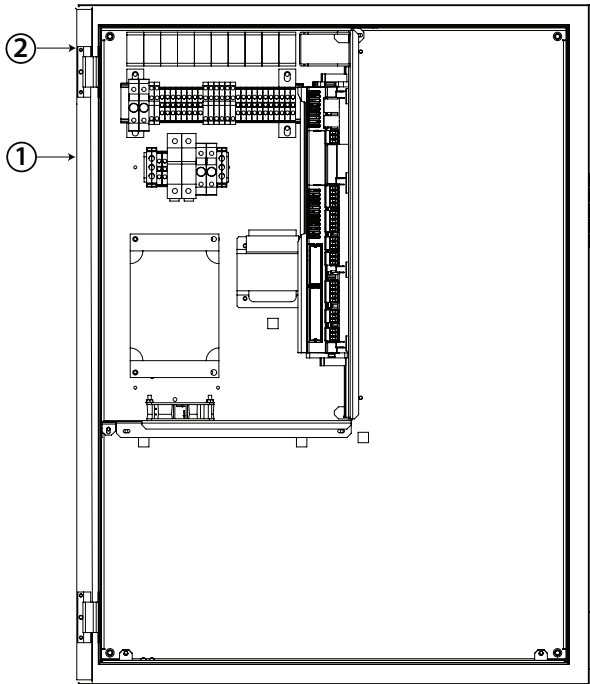

Fig. 3.a

- 1. power supply
- 2. control terminal block

3.2 Power supply

- Depending on the model:
- EC*****0 voltage 230Vac 50Hz
 - EC*****U voltage 230Vac 60Hz

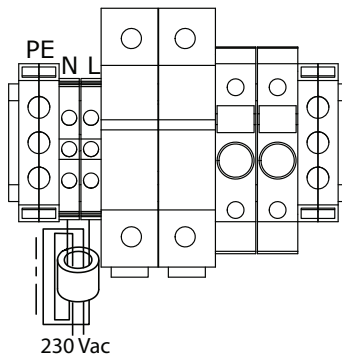

Fig. 3.b

⚠ Important: The cables must conform to local standards. Install a power switch outside the humidifier to completely isolate the mains power supply, with earth (fault protection 30 mA) the earth cable must be mechanically protected and not exposed. The unit is not compatible with IT power supply systems. The single-pole current breaking switch must be fitted upstream of the device.

3.3 Connections to the pCO

The connections listed below are to be made directly to the pCO terminals.

J2	B1	Main humidification/winter (DEC) control probe
	B2	Humidification/winter (DEC) limit probe
	B3	Recovery activation (IEC) configurable analogue signal
J3	B5	AUX temperature probe (only NTC or PT100)
J4	Y1	0-10V signal output for controlling another cabinet
J6	B6	Main evaporative cooling/summer (IEC) control probe
	B7	Evaporative cooling/summer (IEC) limit probe

Tab. 3.a

3.4 Connections to the terminal board.

PEN/GO	Pump / On-Off remote enabling
DEC/GO	Humidification control signals from external voltage-free contact, humidistat type ON/OFF
IEC/GO	Evaporative cooling control signals from external voltage-free contact, thermostat type ON/OFF
PR/GO	Humidification/winter or evaporative cooling/summer priority
REC/GO	Recovery activation (IEC) signal, type ON/OFF
ROAL/GO	Water treatment system alarm signal
ROW/GO	Water treatment system anomaly signal
BKUP/GO	Backup cabinet signal
FLUX/GO	Air flow switch
SC/GO	Droplet separator clogging signal from differential pressure switch
RWL/GO	Not used
AF/AF	Antifreeze activation output
HBT/HBT	Sign of life, this cabinet
RWP/GO	Not used
ROEN/GO	Water treatment system control
AL/AL	Cumulative alarm relay output
NO1/GO	Solenoid valve (optional) step 1
NO2/GO	Solenoid valve (optional) step 2

Tab. 3.b

Remoto ON/OFF

Cables • up to 30 m: two-wire cable AWG20/22 electrical specifications for the contact voltage-free contact

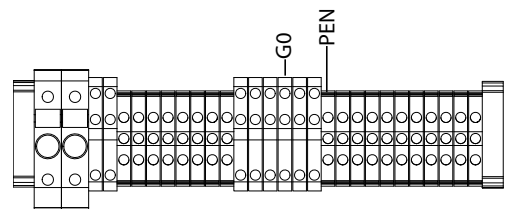

Fig. 3.c

Key:
Remote pump ON/OFF

CONNECTIONS

Cabinet	Remote ON/OFF
PEN (pump enabling)	NC/NO
G0A	COM

ⓘ Please Note: the unit is supplied with jumpers on the PEN-G0A contacts.

3.5 Control signals from external voltage-free contact, humidostat or thermostat type

ON/OFF (control C)

For humidification / direct evaporative cooling (DEC):

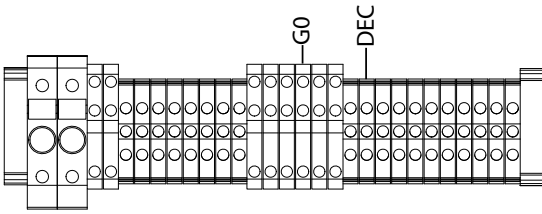

Fig. 3.d

Cabinet	
DEC	NO (OFF) / NC (ON)
GO	COM

For indirect evaporative cooling (IEC):

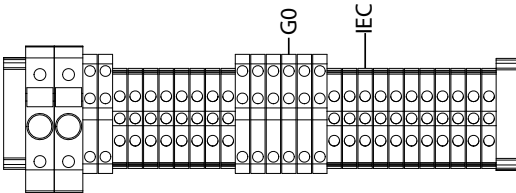

Fig. 3.e

Cabinet	
IEC	NO (OFF) / NC (ON)
GO	COM

Priority humidification / cooling (PR):

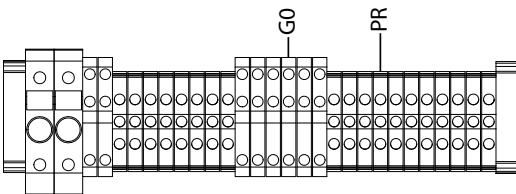

Fig. 3.f

Cabinet	
PR	NO (winter) / NC (summer)
GO	COM

Indirect evaporative cooling enable (REC):

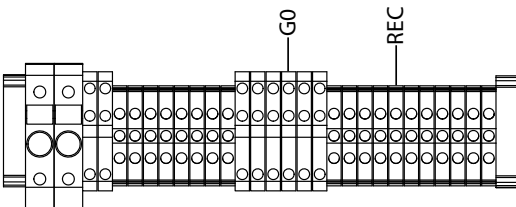

Fig. 3.g

Cabinet	
REC	NO (OFF) / NC (ON)
GO	COM

Starting up damper

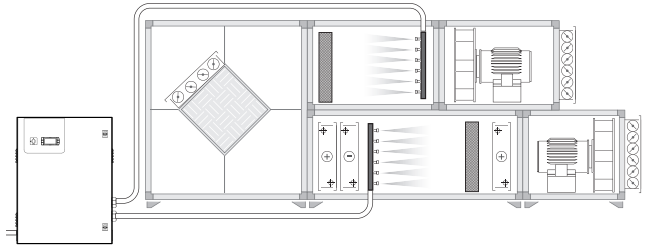

Fig. 3.h

ON/OFF and limit probe (control CH/CT)

For direct/winter (DEC) humidification:

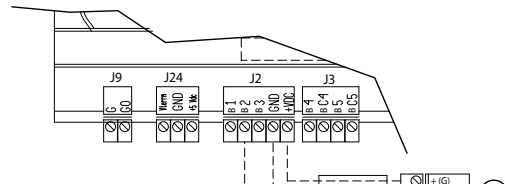
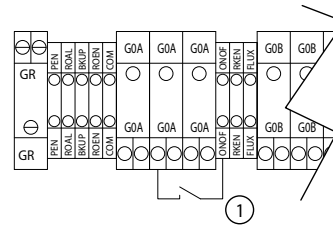

Fig. 3.i

Key:

- 1. humidistat ON/OFF
- 2. humidity/temperature limit probe

ON/OFF and limit probe (control CH/CT)

For evaporative cooling / indirect humidification (IEC):

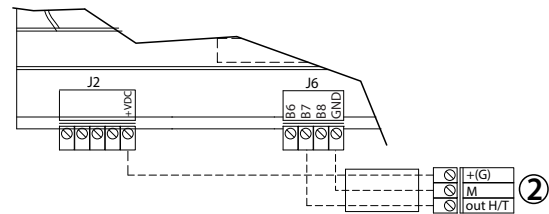
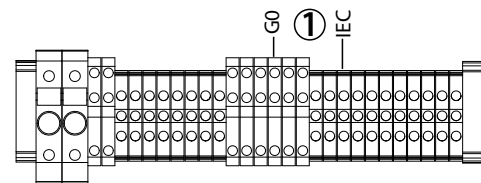

Fig. 3.j

Key:

- 1. humidistat ON/OFF
- 2. humidity/temperature limit probe or signal

ON/OFF and limit flow signal (control CF)

For evaporative cooling / indirect humidification (IEC)

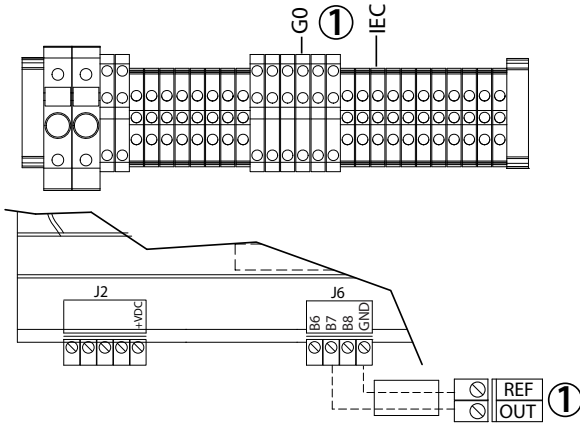

Fig. 3.k

Key:
1. IEC fan / damper modulating signal

3.6 Modulating control signal

The control signal input connections depend on the activated control algorithm.

Cables up to 30 m: two-wire cables cross-section 0.5 mm² (AWG20)

To control the section for direct humidification (DEC: Direct Evaporative Cooling), the signal can come from:

- modulating control with external controller
- modulating control with limit probe (temperature or humidity)
- modulating control with humidity probe
- modulating control with humidity probe and limit probe (temperature or humidity)

To control the section for indirect humidification (IEC: Indirect Evaporative Cooling), on the other hand, the signal can come from:

- modulating control with external signal
- modulating control with limit signal (temperature or humidity probe or air flow-rate/flow limit signal)
- modulating control with temperature probe
- modulating control with temperature probe with limit signal (temperature or humidity probe or air flow-rate/flow limit signal)

Tab. 3.c

To set the type of operation, control and signal: "installer menu > control type (see chap. 9.11 Installer Menu)."

Note: The use of shielded cables is recommended. The cables must not be lodged near power cables at 230 V or near remote control switch wiring: this way, the risk of measurement error risks from electromagnetic interference can be avoided.

Modulating control with external controller (contr. P)

For humidification / direct evaporative cooling (DEC):

0...1 V; 0...10 V; 2...10 V; 0...20 mA; 4...20 mA.

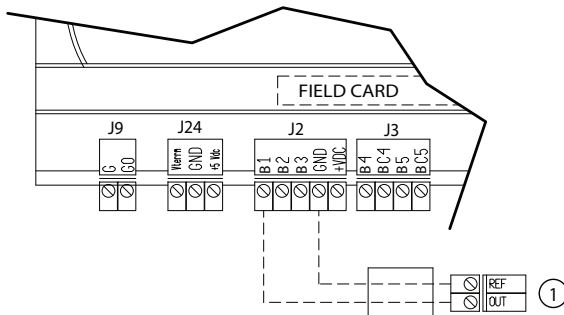

Fig. 3.l

Key:
1. external controller

Connections:

	Cabinet optiMist	External controller
J2	B1	OUT
	GND	Reference, Shield

Per raffrescamento evaporativo (IEC)

Collegamenti:

	Cabinet optiMist	External controller
J6	B6	OUT
	GND	Reference, Shield

Modulating control with control probe

For humidification / direct evaporative cooling (DEC) and ambient humidity control (H control):

0...1 V; 0...10 V; 2...10 V; 0...20 mA; 4...20 mA

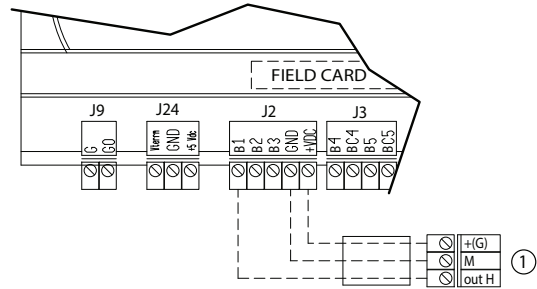

Fig. 3.m

Key:
1. humidity probe

Connections:

	Cabinet optiMist	Ambient humidity probe
J2	B1	OUT H
	+Vdc	+ (G)
	GND	Reference, shield

For evaporative cooling (IEC), temperature control (T control):

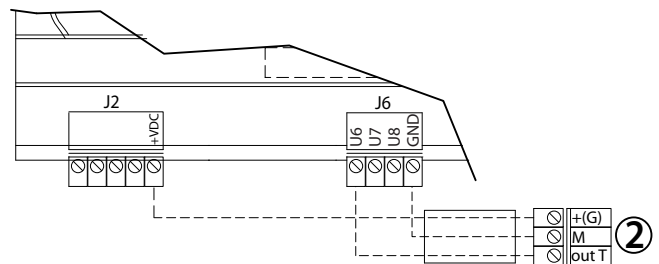

Fig. 3.n

Key:
2. temperature probe

Connections:

	Cabinet optiMist	Temperature probe
J6	B6	OUT T
J2	+Vdc	+ (G)
J6	GND	Reference, shield

Modulating control with controller and limit probe (PH/PT control)

For direct/winter (DEC) humidification:
0...1 V; 0...10 V; 2...10 V; 0...20 mA; 4...20 mA

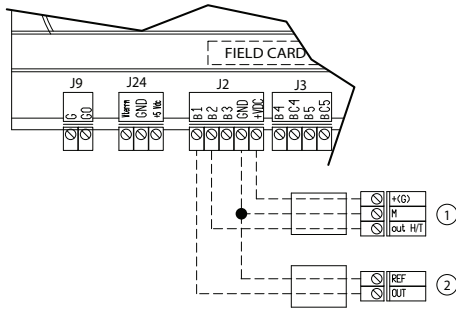

Fig. 3.0

- Key:
1. humidity/temperature limit probe
2. external controller

Connections:

	optiMist cabinet	External controller	Limit probe
J2	B1	OUT	
	B2		OUT H/T
	+Vdc		+(G)
	GND	Reference, shield	Reference, shield

For evaporative cooling (IEC),

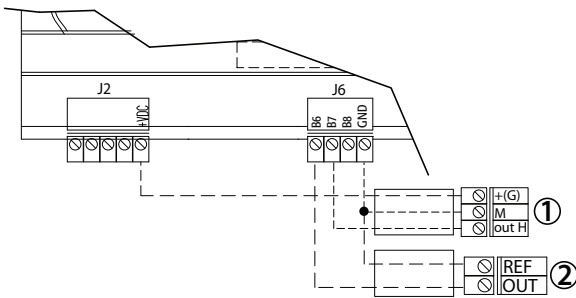

Fig. 3.p

CONNECTIONS

	optiMist cabinet	External controller	Limit probe
J6	B6	OUT	
	B7		OUT H/T
J2	+Vdc		+(G)
J6	GND	Reference, shield	Reference, shield

Modulating control with controller and limit flow signal (PF control)

0...1 V; 0...10 V; 2...10 V; 0...20 mA; 4...20 mA

For evaporative cooling (IEC),

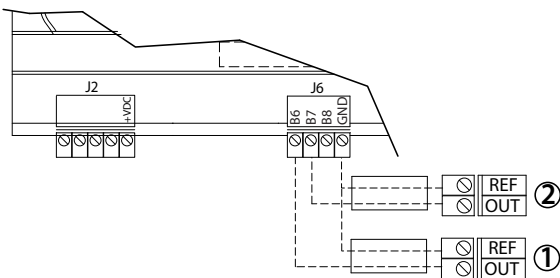

Fig. 3.q

- Key:
1. external controller.
2. IEC fan / damper modulating signal

Modulating control with ambient humidity probe and temperature and humidity limit probe (HH/HT control)

0...1 V; 0...10 V; 2...10 V; 0...20 mA; 4...20 mA

For direct/winter (DEC) humidification:

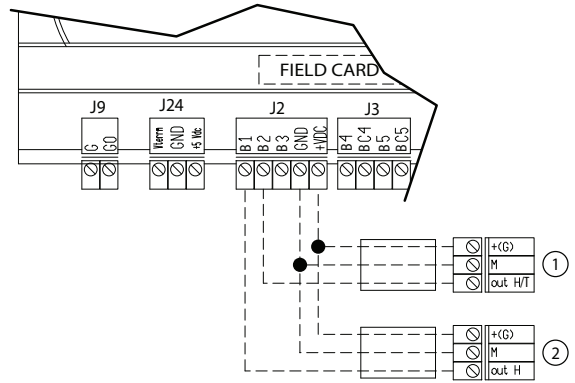

Fig. 3.r

- Key:
1. humidity/temperature limit probe;
2. humidity probe .

CONNECTIONS:

	optiMist cabinet	Humidity probe	Limit probe
J2	B1	OUT H	
	B2		OUT H/T
	+Vdc	+(G)	+(G)
	GND	Reference, shield	Reference, shield

For evaporative cooling (IEC):

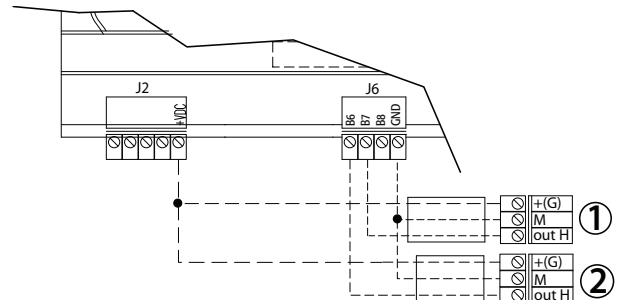

Fig. 3.s

- Key:
1. H/T limit probe;
2. temperature probe.

CONNECTIONS:

	optiMist cabinet	Temperature probe	Limit probe
J6	B6	OUT	
	B7		OUT H/T
J2	+Vdc	+(G)	+(G)
J6	GND	Reference, shield	Reference, shield

3.7 Discharge solenoid valve connection for distribution (optional)

For distribution system management, the cabinet controls the discharge solenoid valves for the two steps: two solenoid valves of the normally open type (NO). Recommended connection cables: two-wire plus earth AWG13 (sec. 1.5 mm²) for lengths up to 100 m.

Insert solenoid valve terminal board connection diagram.

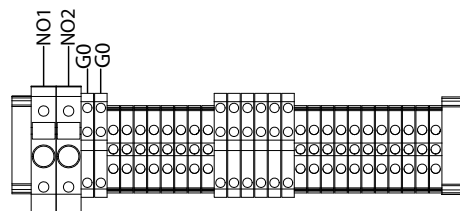

Fig. 3.t

3.8 Water treatment system control

Water treatment activated:

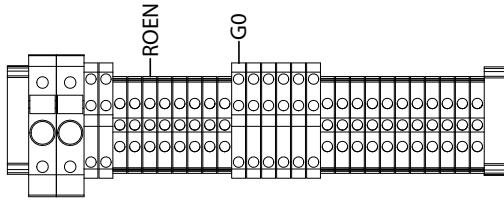

Fig. 3.u

Cabinet	
ROEN	0 Vac (off) / 24 Vac (active)
GO	COM

Note: the ROEN/COM contact can be used as a unit status contact: 0 Vac (standby), 24 Vac (operating).

Signal from water treatment system:

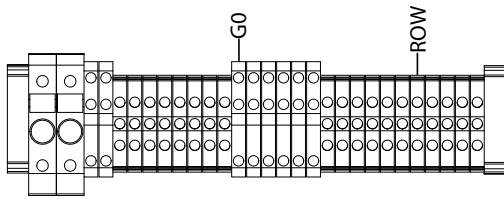

Fig. 3.v

Cabinet	
ROW	NO (warning signal) / NC (active)
GO	COM

Alarm from water treatment system:

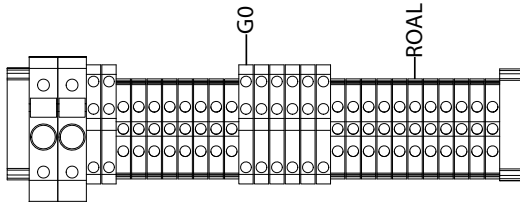

Fig. 3.w

Cabinet	
ROAL	NO (warning) / NC (attivo)
GO	COM

N.B.: the unit is supplied with a jumper on ROAL-G0 terminals

3.9 Cumulative alarm output (J15)

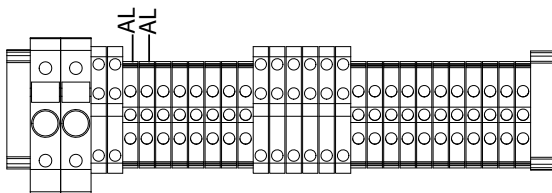

Fig. 3.x

CONNECTIONS:		
J15	Cabinet optiMist	Terminal
	ALL	normally open
	ALL	COM

3.10 Alarm inputs from external devices

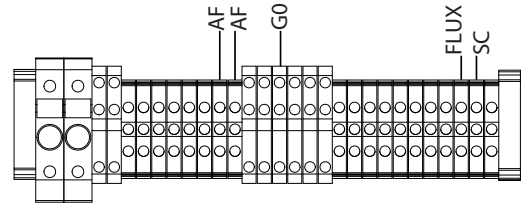

Fig. 3.y

Alarm air-flux (FLUX):

Cabinet	
FLUX	NO (Alarm) / NC (ON)
G0	COM

Alarm drop separator clogged (SC):

Cabinet	
SC	NO (Alarm) / NC (ON)
G0	COM

N.B.: the unit is supplied with a jumper on SC-G0 and FLUX-G0 terminals

3.11 Frost protection alarm output

Alarm / Frost protection activation (AF):

Cabinet	
AF	NO (T>5°C OFF) / NC (T<5°C ON)
AF	COM

3.12 Backup cabinet signal

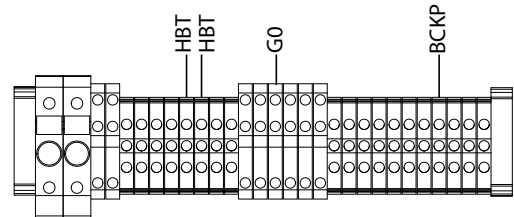

Fig. 3.z

Backup function

The backup function allows the activation of a supporting cabinet in case of unexpected switch-off of the main cabinet.

Two types of backup management are available:

- HBT: control on the heartbeat of the main control
- BMS: control by supervisor

The HBT control allows the activation of the backup cabinet keeping controlled the heartbeat (digital output HBT) of the main Optimist. Wiring the digital contact HBT with the BKUP input of the backup cabin, the backup function check if the heartbeat is active (BKUP contact closed). If the signal dies (BKUP contact opened), the backup cabin starts working.

The BMS control check the status of the DIG 75 variable.

If the variable is 1, the backup cabin is off; if it switches to 0, the backup cabin starts working.

Note: The enabling of the backup function must be set only in the Optimist for backup, inside "Zone Menu → Special Function 2/3" in Installer menu

Backup cabinet signal (BCKP):

Cabinet	
BCKP	NO (main OFF) / NC (principale ON)
G0	COM

Segnale di vita cabinet (HBT):

Cabinet	
HBT	NO (back up OFF) / NC (back up ON)
HBT	COM

Rotation function

The rotation function allows the periodical activation of the two cabins.

In the main cabin:

- enable Rotation function, without enabling the backup;
- set the Rotation time value.

In the backup cabin the HBT control must be set.

To permit the rotation to work, the wiring of the HBT control must be done from the main cabin to the backup one and vice versa.

3.13 Supervisor network

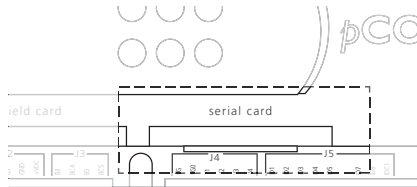

Fig. 3.aa

Optional CAREL cards

	network/card	protocol supported
PCOS004850	RS485	CAREL, Modbus®
PCO100MDM0	RS232 (external modem)	CAREL for remote connections
PCO1000WB0	Ethernet™	TCP/IP SNMP v1 & v2c BACnet™ Ethernet™ ISO8802-2/8802-3 BACnet/IP
PCO1000BA0	Ethernet™ (Modbus®)	BACnet™ MS/TP

Tab. 3.d

! **Important:** Follow the instructions shown on the optional cards for the technical specifications, connections and expansion boards.

Default: CAREL supervisor protocol.

3.14 Supervisory optiMist Table

Type	Carel Index	Modbus® Index	Name	Description	R/W	Min Limit	Max limit	Def.	Unit of measure
Alarms	1	1	Al_No_Model	Alarm: model not yet configured	R	0	1		
	2	2	Al_Setting_Nominal_MFR	Alarm: capacity of the distribution system not yet configured	R	0	1		
	3	3	Al_RO_Not_Ready	Alarm: Water Treatment System	R	0	1		
	4	4	mAl_LP_Detected_New	Alarm: Low Pressure by pressostat (ID5)	R	0	1		
	5	5	Al_high_Temp_Bypass	Alarm: High temperature water in bypass	R	0	1		
	6	6	Al_VFD_Not_Ready	Alarm: Inverter	R	0	1		
	8	8	Al_Antifreeze_Temp	Alarm: low temperature in cabinet	R	0	1		
	9	9	Al_HP_Detected	Alarm: drop separator clogged	R	0	1		
	10	10	mAl_High_Press	Allarme: alta pressione da sonda	R	0	1		
	11	11	mAl_LP_Probe	Alarm: low pressure by probe	R	0	1		
	12	12	mAl_Probe8_Broken	Alarm: pressure probe broken or unconnected	R	0	1		
	13	13	mAl_Probe1_Broken	Alarm: I.E.C. - main probe broken or unconnected	R	0	1		
	14	14	mAl_Probe2_Broken	Alarm: I.E.C. - limit probe broken or unconnected	R	0	1		
	15	15	mAl_Probe6_Broken	Alarm: I.E.C. - main probe broken or unconnected	R	0	1		
	16	16	mAl_Probe7_Broken	Alarm: I.E.C. - limit probe broken or unconnected	R	0	1		
	17	17	mAl_Probe5_Broken	Alarm: AUX probe broken or unconnected	R	0	1		
	18	18	Clock_Error	Error reading/writing the RTC (real time clock) data and/or clock RAM	R	0	1		
	19	19	mAl_Probe4_Broken	Alarm: water temperature probe broken or unconnectd	R	0	1		
	20	20	Al_High_humid	Alarm: HUMIDIFICATION high humidity	R	0	1		
	21	21	Al_Low_Humid	Alarm: HUMIDIFICATION low humidity	R	0	1		
	22	22	Al_Limit_Humid	Alarm: HUMIDIFICATION high limit temperature/humidity	R	0	1		
	23	23	Al_High_Temp_EC	Alarm: I.E.C. high limit temperature	R	0	1		
	24	24	Al_Limit_Humid_EC	Alarm: I.E.C. high limit temperature/humidity	R	0	1		
	25	25	mAl_Probe3_Broken	Alarm: I.E.C. heat recovery activation signal by analog input broken or unconnected	R	0	1		
	26	26	Al_warn_RO	Warning: Water Treatment System	R	0	1		
Analg.	1	1	View_Value	HUMID: main/regulation probe [B1]	R	-20,0 -4,0 0 100,0	70,0 158,0 100,0 100,0		°C /°F / %rH / %
	2	2	View_Value_Lim	HUMID:: limit probe [B2]	R	-20,0 -4,0 0 100,0	70,0 158,0 100,0 100,0		°C /°F / %rH / %
	3	3	View_Value_EC	I.E.C.: main/regulation probe [B6]	R	-20,0 -4,0 0 2	70,0 158,0 100,0 100,0		°C /°F / %rH / %

Analog.	4	4	View_Value_Lim_EC	I.E.C.: limit probe [B7]	R	-20,0 -4,0 0 3 100,0	70,0 158,0 100,0 100,0		°C /°F / %rH / %	
	5	5	Probe3_Value	I.E.C.: Heating recovery activation analog signal [B3]	R	0	100,0		%	
	6	6	T_Probe_View	Water temperature [B4]	R	-20,0 -4,0 158,0	70,0 158,0		°C/°F	
	7	7	View_Value_AUX	AUX probe temperature [B5]	R	-20,0 -4,0 158,0	70,0 158,0		°C/°F	
	8	8	P_Probe_View	Pressure of outlet water [B8]	R	0	20,0 / 300		bar/psi	
	9	9	Setp_Humid	HUMID: Main regulation humidity sepoint	R/W	0	100,0	50,0	%rH	
	10	10	Humid_Diff	HUMID: Main regulation humidity delta	R/W	0	100,0	5,0	%rH	
	11	11	L_Humid_Set	HUMID: Limit probe humidity sepoint [%rH]	R/W	0	100,0	100,0	%rH	
	12	12	L_Humid_Diff	Humid: Limit probe humidity delta [%rH]	R/W	0	100,0	5,0	%rH	
	13	13	L_Temp_Set	Humid.: Limit probe temperature sepoint	R/W	0	100,0	25,0 77,0	°C/°F	
	14	14	L_Temp_Diff	Humid: Limit probe temperature delta	R/W	0	100,0	5,0 41	°C/°F	
	15	15	Main_Prb_Setpoint_EC	I.E.C.: Main regulation temperature sepoint	R/W	0	99,9	25,0/77,0	°C/°F	
	16	16	Main_Prb_Delta_EC	I.E.C.: Main regulation temperature delta	R/W	0	99,9	2,0 / 35	°C/°F	
	17	17	Main_Prb_Band_EC	I.E.C.: Main regulation temperature band	R/W	0	99,9	5,0 / 41	°C/°F	
	18	18	Limit_Prb_Setp_HF_EC	I.E.C.: Limit probe humidity sepoint	R/W	0	100,0	95,0	%rH	
	19	19	Limit_Prb_Band_HF_ECHF	I.E.C.: Limit probe humidity delta	R/W	0	100,0	5,0	%rH	
	20	20	Limit_Prb_Setp_T_EC	I.E.C.: Limit probe temperature sepoint	R/W	0	99,9	20,0 / 68	°C/°F	
	21	21	Limit_Prb_Band_T_ECHF	I.E.C.: Limit probe temperature delta	R/W	0	99,9	5,0 / 41	°C/°F	
	22	22	High_Room_Humid	HUMID: threshold high humidity by main regulation probe reading	R/W	0	100,0	100,0	%rH	
	23	23	Low_Room_Humid	HUMID: threshold low humidity by main regulation probe reading	R/W	0	100,0	0	%rH	
	24	24	High_Limit_Humid	HUMID: threshold high humidity by limit probe reading	R/W	0	100,0	100,0	%rH	
	25	25	High_Limit_Temp	HUMID: threshold high temperature by limit probe reading	R/W	0	150,0	40,0/104	°C/°F	
	26	26	High_Room_Temp_EC	I.E.C.: threshold high temperature by main regulation probe reading	R/W	0	150,0	40,0/104	°C/°F	
	27	27	Low_Room_Temp_EC	I.E.C.: threshold low temperature by main regulation probe reading	R/W	0	150,0	10,0 / 50	°C/°F	
	28	28	High_Limit_Humid_EC	I.E.C.: threshold high humidity by limit probe reading	R/W	0	100,0	100,0	%rH	
	29	29	High_Limit_Temp_EC	I.E.C.: threshold high temperature by limit probe reading	R/W	0	150,0	40,0/104	°C/°F	
	Dig.	41	41	Unit_Measure	Unit measure (0=International System; 1= Imperial)	R/W	0	1		
		42	42	Type_Machine_208	Supply voltage (0= 230V 50Hz; 1=230V 60Hz)	R	0	1		
		43	43	Priority_Humidity_Running	Zone running (0=I.E.C., 1= Humidification)	R	0	1		
		44	44	Priority_Humidity_Din	Priority summer/winter mode by digital input (0=I.E.C., 1=Humidification)	R	0	1		
		45	45	Heat_Recovery_Active	I.E.C.: heat recovery status (0=Not active; 1=Active)	R/W	0	1		
		46	46	Lim_Flow_EC_Type	I.E.C.: Flow limit signal type(0=Damper; 1=Fan)	R	0	1		
		47	47	Dout_02	Pump activation status [Dout 02]	R	0	1		
		48	48	Dout_10	Water treatment system status [Dout 10]	R	0	1		
		49	49	Dout_01	Main line fill valve status (0=closed; 1=opened) [Dout 1]	R	0	1		
50		50	Dout_04	Step 1 fill valve status (0=closed; 1=opened) [Dout 4]	R	0	1			
51		51	Dout_05	p 2 fill valve status (0=closed; 1=opened) [Dout 5]	R	0	1			
52		52	Dout_06	Step 1 drain valve status (0=closed; 1=opened) [Dout 6]	R	0	1			
53		53	Dout_09	Step 2 drain valve status (0=closed; 1=opened) [Dout 9]	R	0	1			
54		54	Dout_03	Main line drain valve status (0=closed; 1=opened) [Dout 3]	R	0	1			
55		55	Req_Wash	Request of wash procedure running	R	0	1			
56		56	Dout_13	Anti-freeze procedure activation[Dout 13]	R	0	1			
57		57	Dout_12	Heartbeat of this cabinet [Dout 12]	R	0	1			
58		58	Heartbeat_Din	BACKUP: Other cabinet heartbeat by digital input [ID 4]	R	0	1			
59		59	Superv_OnOff	On/Off by supervisor (0=Off, 1=On)	R/W	0	1			
60		60	En_Scheduler	Enable time scheduler	R/W	0	1	0		
61		61	En_Reg_From_Superv	HUMIDIFICATION: enable regulation by supervisor	R/W	0	1	0		
62		62	En_Reg_EC_From_Superv	I.E.C.: enable regulation by supervisor	R/W	0	1	0		
63		63	Heat_Recovery_Active_BMS	Enable heat recovery by supervisor	R/W	0	1	0		
64		64	En_Defrost	Enable anti-freeze function	R/W	0	1	0		
65		65	RESET_ALARMS	Request to reset/clear alarm memories	R/W	0	1	0		
66		66	SET_DAY	Request to copy NEW_DAY into DAY	R/W	0	1	0		
67		67	SET_MONTH	Request to copy NEW_MONTH into MONTH	R/W	0	1	0		
68		68	SET_YEAR	Request to copy NEW_YEAR into YEAR	R/W	0	1	0		
69		69	SET_HOUR	Request to copy NEW_HOUR into HOUR	R/W	0	1	0		
70		70	SET_MINUTE	Request to copy NEW_MINUTE into MINUTE	R/W	0	1	0		
71		71	Remote_Hum_Req	HUMIDIFICATION: request by on/off contact	R	0	1			
72		72	Remote_EC_Req	I.E.C.: request by on/off contact	R	0	1			
73		73	Air_Flow_Switch	Flux digital input status [ID 9]	R	0	1			
74		74	Aux_Enabled	Enable AUX probe [B5]	R/W	0	1			
75		75	HeartBeat_Superv	BACKUP: heart heartbeat other cabinet (by supervisor)	R/W	0	1			
76	76	En_rotation	Enable rotation between two cabinets	R/W	0	1				
77	77	Default_Ahead	Memory erasing and default values intallation running	R	0	1				
78	78	Heart_Beat_RC2	Test pCO (write 1, after 2 s this variable is reset)	R/W	0	1				
Int.	1	209	Type_Machine_Display	Model of the cabinet	R	1	13			
	2	210	Qa_N_Pump_Display	Pump capacity	R	0	1000 2200		kg/h / lb/h	
	3	211	N_Steps	Number of steps present	R	1	2			
	4	212	Qa_N_Rack_X	HUMIDIFICATION: steps capacity	R	0	1000 2200			
	5	213	Qa_N_Rack_2_X	I.E.C.: steps capacity	R	0	1000 2200			
	6	214	Installation_Type	Installation type (0=I.E.C., 1=Humidification, 2= Humidification.+ I.E.C.)	R	0	2			
	7	215	Unit_Status	Main mask status visualization (0=OFF BY SCHEDULER;1=REMOTE OFF;2=OFF BY KEYBOARD;3=OFF BY SUPERVISOR;4=OFF BY FLUXOSTAT;5=PUMP OFF BY KEYBOARD;6=PUMP OFF BY REMOTE;7=PRE SSURIZATION;8=WATER INLET WAITING;9=OFF BACKUP;10=ALARM;11=W ARNING;12=not used...;13=TEST PRESS. IN;14=FILLING;15=WASHING;16=R EADY;17=PRODUCTION;18=BYPASS CALIBRATION;19=INIZIALIZATION)	R	0	19			
	8	216	Main_Status	Main status	R	0	25			
	9	217	Qr_Pump	0-10V signal to inverter (0-1000) [Aout Y2]	R	0	1000			
	10	218	Regulation_Type	HUMIDIFICATION: Regulation type 0=Reg.Humidity, 1=Reg.hum.+Limit Humid., 2=Reg.Humid+Limit Temp, 3=Not used, 4=Not used, 5=Not used, 6=External prop.signal, 7=Ext.signal+limit Humid, 8=Ext.signal+limit Temp,9=ON/OFF ext.contact	R	0	9			
	11	219	Humidity_Cfg	HUMIDIFICATION: Main probe type (0=NTC;1=0-1 V; 2=2-10 V;3= 0-10 V; 4=0-20 mA; 5=4-20 mA; 6=0-135 ohm; 7=135-1k ohm)	R	0	7			
	12	220	Limit_Cfg	HUMIDIFICATION: Limit probe type (0=NTC;1=0-1 V; 2=2-10 V;3= 0-10 V; 4=0-20 mA; 5=4-20 mA; 6=0-135 ohm; 7=135-1k ohm)	R	0	7			

	13	221	Regulation_Type_EC	I.E.C.: Regulation type (0=Temp.reg., 1=Temp.+Lim.Hum,2=Temp.+Lim.Temp,3=Temp.+Lim.Flow, 4=prop.signal., 5=prop.signal+lim.Hum,6=prop.signal+lim.Temp., 7=prop.signal+lim.Flow, 8=ON/OFF cont,9=ON/OFF+lim.Humid,10=ON/OFF+lim.Temp,11=ON/OFF+lim.flow)	R	0	11		
	14	222	Main_Cfg_EC	I.E.C.: Main probe type (0=NTC;1=0-1 V; 2=2-10 V;3= 0-10 V; 4=0-20 mA; 5=4-20 mA; 6=0-135 ohm; 7=135-1k ohm)	R	0	7		
	15	223	Limit_Cfg_EC	I.E.C.: Limit probe type (0=NTC;1=0-1 V; 2=2-10 V;3= 0-10 V; 4=0-20 mA; 5=4-20 mA; 6=0-135 ohm; 7=135-1k ohm)	R	0	7		
	16	224	Reg_Superv_Value	HUMIDIFICATION: 0-1000 request by supervisor (active only if regulation by supervisor enabled)	R/W	0	1000	0	
	17	225	Reg_EC_Superv_Value	I.E.C.: 0-1000 request by supervisor (active only if regulation by supervisor enabled)	R/W	0	1000	0	
	18	226	Act_production_RC	Actual production	R	0	1000 / 2200		kg/h / lb/h
	19	227	RC_Kg_Req_View	Actual request	R	0	1000 / 2200		kg/h / lb/h
	20	228	P_High	Maximum step modulation pressure	R	P_Low	150	15,0 / 217	decimi di bar psi
	21	229	P_Low	Minimum step modulation pressure	R	0	P_High	4,0 / 58	decimi di bar psi
	22	230	LP_Probe_Dly	Low pressure by probe alarm delay	R/W	0	999	60	s
	23	231	Auto_Wash_Type	Wash type (0=Only drain; 1=daily wash; 2=Periodical wash)	R/W	0	2	2	
	24	232	Auto_Wash_Every_Time	Periodical wash: time between two washing requests [hours]	R/W	0	999	24	hours
	25	233	Auto_Wash_Hour	Daily washing: activation hour	R/W	0	23	12	hours
	26	234	Auto_Wash_Minute	Daily washing: activation minute	R/W	0	59	0	min
	27	235	Wash_Duration	Washing time duration	R/W	1	120	2	min
	28	236	Running_H_Pump_TOT_Compact	Pump working hours	R	0	32767		hours
	29	237	Running_H_Pump_Compact	Cabinet working hours	R	0	32767		hours
	30	238	fascia1_ore_on1	Scheduler: P1-1 ON hour	R/W	0	23	0	hours
	31	239	fascia1_min_on1	Scheduler: P1-1 ON minute	R/W	0	59	0	min
	32	240	fascia1_ore_off1	Scheduler: P1-1 OFF hour	R/W	0	23	0	hours
	33	241	fascia1_min_off1	Scheduler: P1-1 OFF minute	R/W	0	59	0	min
	34	242	fascia1_ore_on2	Scheduler: P1-2 ON hour	R/W	0	23	0	hours
	35	243	fascia1_min_on2	Scheduler: P1-2 ON minute	R/W	0	59	0	min
	36	244	fascia1_ore_off2	Scheduler: P1-2 OFF hour	R/W	0	23	0	hours
	37	245	fascia1_min_off2	Scheduler: P1-2 OFF minute	R/W	0	59	0	min
	38	246	fascia2_ore_on	Scheduler: P2 ON hour	R/W	0	23	0	hours
	39	247	fascia2_min_on	Scheduler: P2 ON minute	R/W	0	59	0	min
	40	248	fascia2_ore_off	Scheduler: P2 OFF hour	R/W	0	23	0	hours
	41	249	fascia2_min_off	Scheduler: P2 OFF minute	R/W	0	59	0	min
	42	250	monday_type	Monday scheduling (0=P1; 1=P2; 2=P3 [always ON]; 3=P4 [always OFF])	R/W	0	3	0	
	43	251	tuesday_type	Tuesday scheduling (0=P1; 1=P2; 2=P3 [always ON]; 3=P4 [always OFF])	R/W	0	3	0	
	44	252	wednesday_type	Wednesday scheduling (0=P1; 1=P2; 2=P3 [always ON]; 3=P4 [always OFF])	R/W	0	3	0	
	45	253	thursday_type	Thursday scheduling (0=P1; 1=P2; 2=P3 [always ON]; 3=P4 [always OFF])	R/W	0	3	0	
	46	254	friday_type	Friday scheduling (0=P1; 1=P2; 2=P3 [always ON]; 3=P4 [always OFF])	R/W	0	3	0	
	47	255	saturday_type	Saturday scheduling (0=P1; 1=P2; 2=P3 [always ON]; 3=P4 [always OFF])	R/W	0	3	0	
	48	256	sunday_type	Sunday scheduling (0=P1; 1=P2; 2=P3 [always ON]; 3=P4 [always OFF])	R/W	0	3	0	
	49	257	BMS_Time_Offline	Waiting time before supervisor offline alarm	R/W	0		60	s
	50	258	BIOS_RELEASE	Indicates the release of the BIOS	R	0	999		
	51	259	Mod_HWSW_check_02.Bios_Day	Data rilascio bios: giorno	R	1	31		
	52	260	Mod_HWSW_check_02.Bios_Month	Data rilascio bios: mese	R	1	12		
	53	261	Mod_HWSW_check_02.Bios_Year	Data rilascio bios: anno	R	0	99		
	54	262	BOOT_RELEASE	Indicates the release of the BOOT	R	0	999		
	55	263	Mod_HWSW_check_02.Boot_Day	Data rilascio boot: giorno	R	1	31		
	56	264	Mod_HWSW_check_02.Boot_Month	Data rilascio boot: month	R	1	12		
	57	265	Mod_HWSW_check_02.Boot_Year	Data rilascio boot: anno	R	0	99		
	60	268	Mod_HWSW_check_02.Day_Sw_Version	Giorno versione applicativo	R	1	31		
	61	269	Mod_HWSW_check_02.Month_Sw_Version	Mese versione applicativo	R	1	12		
	62	270	Mod_HWSW_check_02.Year_Sw_Version	Anno versione applicativo	R	0	99		
	63	271	NEW_DAY	New day	R/W	1	31		
	64	272	NEW_MONTH	New month	R/W	1	12		
	65	273	NEW_YEAR	New Year	R/W	0	99		
	66	274	NEW_HOUR	New Hour	R/W	0	23		hours
	67	275	NEW_MINUTE	New minute	R/W	0	59		min
	68	276	CURRENT_DAY	Current day	R	1	31		
	69	277	CURRENT_MONTH	Current month	R	1	12		
	70	278	CURRENT_YEAR	Current year	R	0	99		
	71	279	CURRENT_HOUR	Current Hour	R	0	23		hours
	72	280	CURRENT_MINUTE	Current minute	R	0	59		min
	73	281	En_Backup	Backup function activation: 0=Off, 1= On by Inqrdig., 2=On by Supervisor	R/W	0	2	0	
	74	282	Max_Prod	HUMIDIFICATION: maximum production	R/W	0	100	100	%
	75	283	Max_Prod_EC	I.E.C.: maximum production	R/W	0	100	100	%
	76	284	Delay_AI_min	HUMIDIFICATION: high/low humidity and high/low limit temperature/umidity alarm delay	R/W	0	999	60	s
	77	285	Delay_AI_min_EC	I.E.C.: high/low temperature and high/low limit temperature/umidity alarm delay	R/W	0	999	60	s
	81	289	Humiset_Check_App_Ver	SW version (X.Y = XY) [Eg.:1.0B23 -->10]	R	10	999		
	82	290	Humiset_Beta_App_Ver	BETA sw release (0=Official, n°>0=Beta version n°)	R	0	999		

Int.

Tab. 3.e

4. PUMPING UNITS

4.1 Pumping unit with flow control configuration

optiMist controls the humidification and/or cooling capacity by continuously controlling the atomised water flow-rate across a wide range of modulation.

This configuration is used in the following applications:

- humidification and/or evaporative cooling (direct) in an AHU;
- humidification and indirect evaporative cooling in an AHU equipped with a heat recovery unit (a single atomisation system atomises the water).

optiMist is equipped with an inverter to continuously and precisely control the speed of the pump and, consequently, the flow-rate.

The outlet pressure is kept within the optimum water atomisation limits by the range of modulation of the pump speed and control of the number of nozzles that atomise the water.

If the flow-rate required for humidification or evaporative cooling is small then a few nozzles will be enough to atomise the water; if the request increases, the increase in flow-rate will cause an increase in pressure that, if it exceeds 15 bar, will activate other atomising nozzles (from the second modulation step) with a subsequent decrease in the pressure, bringing it within the optimum range.

Similarly, if the humidification request decreases, the flow-rate and thus the pressure will decrease and, if the latter approaches 4 bars, some nozzles will be closed so that the pressure returns within the optimum atomisation range.

This is possible because the nozzles are assembled into groups of up to four, with different capacities; when suitably activated, these guarantee continuous modulation of the flow-rate across a wide range, nominally from 40 or 20 at 100% (40% for pump 50, 100 and 200 l/h, 20% for 400, 800, 1000 l/h) the maximum flow-rate.

This is possible because the nozzles are combined together in groups up to two nozzles with different capacities; this means that when activated, they can guarantee continuous flow-rate modulation across a wide range, nominally from 40 or 20 to 100% (20% for 50, 100 and 200 l/h pumps, 40% for 400, 800, 1000 l/h) of maximum capacity.

5. DISTRIBUTION SYSTEM

This paragraph briefly describes the distribution and atomisation systems for AHUs (rack and droplet separator) and for rooms. These are described in detail in the “optiMist – distribution systems” manual.

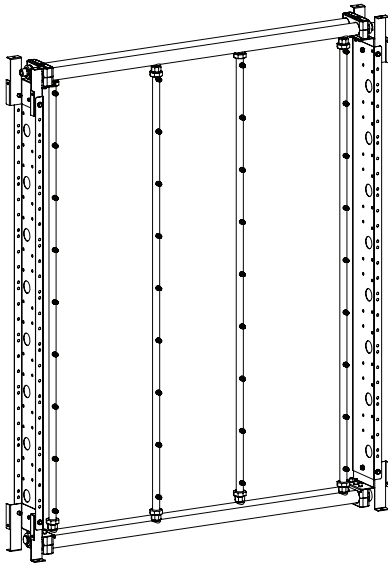

Fig. 5.a

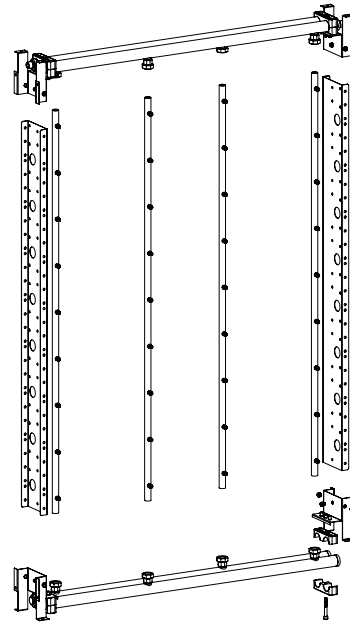

Fig. 5.b

5.1 Distribution and atomisation rack

“n” racks are available which are differentiated by:

- Single nozzle flow-rate
- Width (in modules, each module is 152mm: the total value is obtained by adding 94 to the product of 152 and the number of modules).
- Height (in modules, each module is 152mm: the total value is obtained by adding 68 to the product of 152 and the number of modules).
- water flow-rate in l/h (multiply value *10).
- number of nozzles
- number of circuits

example: ER0_11_07_22_1 (0= 6 l/h; 1= 5 l/h; 2= 4 l/h; 3= 2.5 l/h)

- width: $94 + ("11" * 152)$.
- Height: $68 + ("7" * 152)$.
- Number of nozzles: 22
- Number of circuits "1"

The racks are supplied in unassembled kits; customers are responsible for assembly.

Rack components:

1. AISI 316 stainless steel nozzles with brass adapters from NPT1/8m
2. AISI304 collectors for nozzles, diameter 20mm with orifices from NPT1/8f.
3. AISI304 distributor collectors, diameter 35mm with orifices from G1/2m for compression fittings.
4. Compression fittings for pipes from 20mm and fitting from G1/2f.
5. Corner brackets in AISI304 plate.
6. Vertical profiles in AISI304.
7. Pipe gripping clamps for pipes from 35mm (single or double according to the number of circuits on the rack).
8. Screws for pipe gripping clamps: M8 for double clamp and M6 for single clamp.
9. G1/2m caps in brass to close the orifices not used by the collectors, d.35.
10. M6 screws in AISI304 to assemble the corner brackets and vertical profiles (insert figure)

To connect the nozzles and compression fittings to the discharge valves, use sealants suitable for:

- Thread size.
- Maximum operating temperature.
- Maximum operating pressure.

To correctly discharge the system, each rack is configured for the installation of a discharge solenoid valve.

To ensure the discharge of the rack, they must satisfy the following conditions:

1. The collectors with atomising nozzles must be in the vertical position.
2. The water supply must be connected to the upper horizontal collector with a diameter of 35mm.
3. The discharge solenoid valves must be connected to the lower horizontal collection with a diameter of 35mm.
4. The rack must be tilted at least 1° towards the discharge valves.
5. The connection pipes between the rack and pumping station must be without pockets that could cause water stagnation.

When the rack has a flow-rate of about 75% less than the maximum flow-rate of the pump, instead of discharge solenoid valves, mechanical discharge valves may be used, which do not require wiring; in this case water consumption and discharge and refilling times are slightly increased. The discharge solenoid valves and mechanical valves can be connected directly to the rack and to discharge inside the pipe or they can be moved outside the pipe using the appropriate extension kit (see example kit ACKT1F0500).

In the event of solenoid valve installation directly on the rack, inside the pipe, the width of the rack increases by 10cm. The collectors are populated with atomising nozzles in brass in the appropriate number to achieve the flow-rate reported in the related code digit.

The corner brackets are equipped with holes for mounting in the pipe.

5.2 Droplet separator

The droplet separator catches the droplets of water that aren't completely evaporated in the air, to prevent them from getting downstream objects wet. They are made up of standard size modules that are assembled on a support structure to cover the section of the AHU. The structure, which is entirely made from stainless steel, facilitates drainage of the water captured by the droplet separator. To facilitate maintenance of the individual modules, removal and replacement is done from the front, by removing the appropriate front frame. The modules are available with glass fibre or stainless steel filtering material. They are available in 3 sizes in height and width of the modules, the combination of which leads to 9 standard modules.

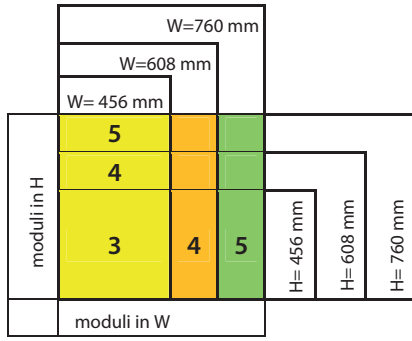

Fig. 5.c

The following table shows the height and width dimensions available and the combinations in installable modules

Separators are differentiated by:

- Width
- Height

They are available in the following heights and widths and number of standard modules:

WIDTH "W"

MODULES	3	4	5	6	7	8	9	10	11	12	13	14	15	16	17	18	19	20
mm	514	666	818	974	1126	1278	1430	1582	1736	1888	2040	2192	2344	2498	2650	2802	2954	3106
no. separators	1	1	1	2	2	2	2	2	3	3	3	3	3	4	4	4	4	4
type separators (no. per mod.)	1x3	1x4	1x5	2x3	1x3+1x4	2x4	1x4+1x5	2x5	2x3+1x5	1x3+1x4+1x5	1x3+2x5	1x4+2x5	3x5	2x3+2x5	1x3+1x4+2x5	3x5+1x3	3x5+1x4	4x5

Tab. 5.a

HIGHT "W"

MODULES	3	4	5	6	7	8	9	10	11	12	13	14	15	16	17	18	19	20
mm	527	679	831	1022	1174	1326	1478	1630	1820	1972	2124	2276	2428	2618	2770	2922	3074	3226
no. separators	1	1	1	2	2	2	2	2	3	3	3	3	3	4	4	4	4	4
type separators (no. per mod.)	1x3	1x4	1x5	2x3	1x3+1x4	2x4	1x4+1x5	2x5	2x3+1x5	1x3+1x4+1x5	1x3+2x5	1x4+2x5	3x5	2x3+2x5	1x3+1x4+2x5	3x5+1x3	3x5+1x4	4x5

Tab. 5.b

There are 324 possible combinations identified by the following coding:

Example: ECDS100710

- width: 07 (mm1126).
- height: 10 (mm1630).

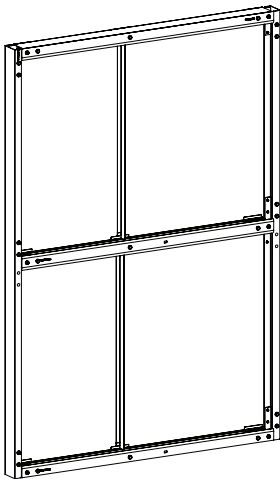

Fig. 5.d

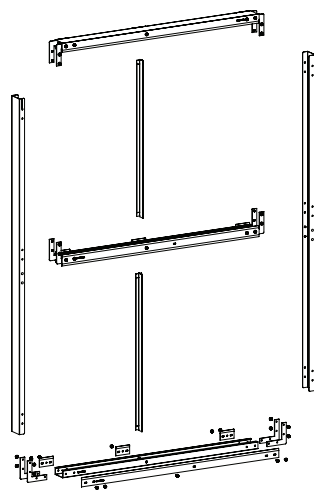

Fig. 5.e

In cases where the droplet separator does not exactly cover the section of the AHU, the free spaces must be closed to prevent the air from bypassing the droplet separator itself. The necessary plugging materials is not supplied by Carel. Flexible or stainless steel pipes are also supplied to connection the pumping station to the rack.

Please note that the installation of a properly drained droplet collection tray is always necessary for the rack, the droplet evaporation chamber and the droplet separator.

The tray is not supplied by CAREL.

6. APPLICATIONS

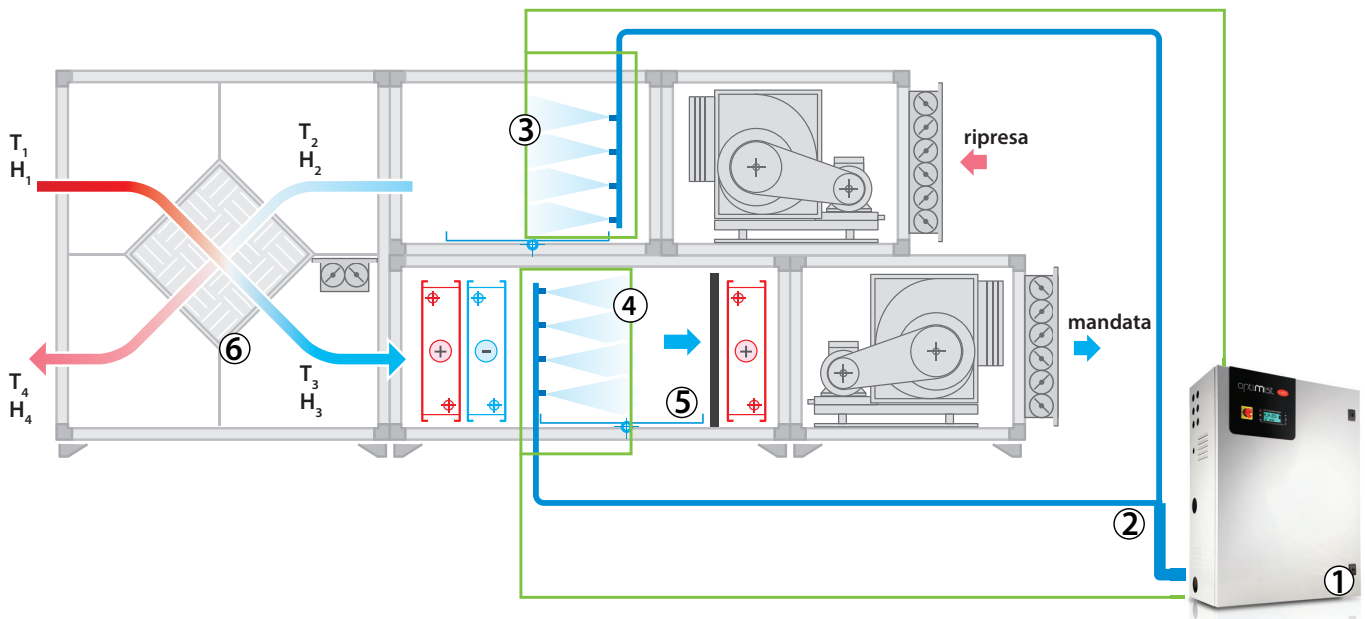

Fig. 6.a

optiMist for AHU/ducts is suitable for all applications in which the air can be humidified and/or cooled evaporatively, atomising demineralised water. Below are some possible applications of optiMist:

- data center
- office buildings
- hotels and call centers
- printing and paper industries
- cleanrooms
- libraries and museums
- textiles industry
- food industry
- direct/indirect evaporative cooling
- timber industry
- other industrial applications.

The possibility of using an atomising rack for indirect evaporative cooling is especially interesting: the air to be discharged is cooled evaporatively (bringing it to saturation) and is then used to cool the fresh outside air using an air-air heat exchanger, as shown in the following figure.

Key:

1. pumping unit and zone controller;
2. pressurised water line;
3. rack for cooling in summer;
4. rack for humidification in winter;
5. droplet separator;
6. heat recovery unit.

6.1 Main advantages of optiMist

The main advantages of optiMist are:

- Highly reduced electrical consumption: about 1 Watt for every litre/hour of humidification capacity;
- Maximum capacity: 1000 kg/h;
- Loading solenoid valves for the distribution system inside the cabinet;
- Excellent humidification and cooling effect in the AHU due to the rack being customised based on the AHU section;
- Very low maintenance required.
- Washing and draining cycles;
- Absence of dripping
- Silent nozzles
- Connectivity: optiMist can be connected to external systems such as BMS using the ModBus protocols, ...
- Back up and rotation between two cabinets.

7. CONTROL

7.1 Humidification

Algorithms, which can be selected from the installer menu.

• HH control:

modulates the capacity (water flow-rate) using two humidity probes, one control probe normally installed in the AHU in the return air, and one limit probe, usually installed downstream of the droplet separator.

• HT control:

modulates the capacity (water flow-rate) with two probes, one humidity control probe and one limit temperature probe. This configuration is recommended for systems in which a certainly humidity level is required without however excessively cooling the air.

• H control:

like the HH algorithm but without the limit humidity probe;

Below is the diagram of operation using humidity control probes

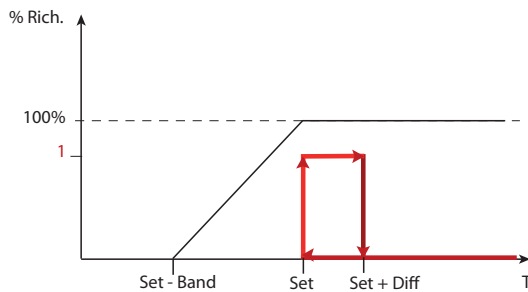

Fig. 7.a

Key:

1. production
2. humidity control probe
3. maximum production
4. minimum production
5. proportional band
6. hysteresis (10% of "5")

• PH/PT control:

capacity is modulated proportionally to an external control signal and is limited based on the value measured by the limit temperature or humidity probe. This is the typical configuration used in optiMist installations connected to a Building Management System that generates a control signal;

• P control:

like the PH/PT algorithm but without the limit humidity probe;
Below is the diagram of operation with proportional control.

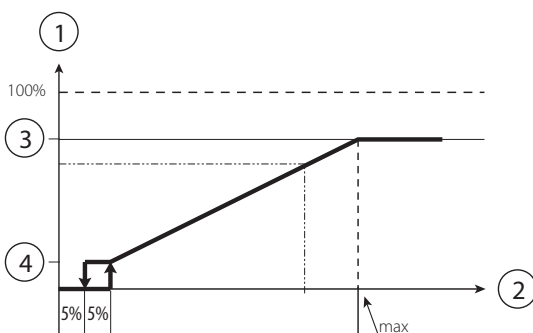

Fig. 7.b

Key:

1. production
2. external request
3. maximum production
4. minimum production

• CH/CT control:

operation in on/off mode, based on a voltage-free external contact (for example, a humidistat). The capacity will thus be either the maximum set or nothing, depending on the status of the external contact, and is limited based on the value measured by the limit probe.

• C control:

like the CH/CT algorithm but without the limit probe;

The HH and TH algorithms are the most commonly-used, and recommended for optiMist installations.

The limit humidity probe described above is usually set to high values, e.g. 80% rH, so as to limit the maximum moisture in the air introduced into the duct and into the room. This is especially recommended in installations where air flow-rate and operating, temperature and humidity conditions, may change over time and, consequently an additional safety system is required to prevent the humidifier from over-humidifying the air and, in the worse case scenario, condensing in the ducts downstream.

Below are the two diagrams of operation with humidity or temperature probes

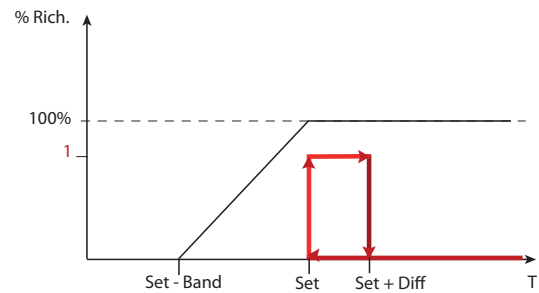

Fig. 7.c

Key:

1. production
2. limit probe
3. maximum production
4. minimum production
5. proportional band
6. hysteresis (10% of the set point)

N.B.: for convenience, the diagrams show continuous modulation of the flow-rate while, depending on the model, control may be continuous or in steps.

• Temperature probe on the rack

The function, configurable under CONFIG. INPUTS 9 and 10, features two distinct modes:

Warning only:

If the temperature is lower than the set point set on screen Bbc06, calculated based on the system sizing, the "Low rack temperature" warning is activated

Warning + Reduction in production:

When the temperature drops below the set point, together with the activation of the warning, production is reduced as the temperature decreases, until it stops completely when the difference between the set point referred to the temperature probe on the rack and the measured temperature is higher than the "Band" set on screen 10.

Operation of the warning and production reduction modes is summarised in the following graph, where all of the parameters indicated can be set on the CONFIG. INPUTS screen.

7.2 Evaporative Cooling

If optiMist is used as an application dedicated to evaporative cooling, the possible controls are:

- TT Control
- TH Control
- TF Control
- T Control
- PH/PT/PF Control
- P Control
- C Control
- CH/CT/CF Control

IMPORTANT: All of these controls require a consent signal that lets the humidifier know when it can operate. This indication corresponds with the activation of the recovery unit in the Air Treatment Unit (ATU); this information can be sent to the humidifier through:

- a modulating 0-10V signal (corresponding to the opening of the renewal air locks) or
- a digital contact or
- a digital variable via supervision (DIG 63).

A delay in the humidifier activation can be set, starting from the activation signal from the recovery unit previously described.

T CONTROL

This type of control consists of a Proportional+Integral type control of the temperature detected by a probe located in the return air, downstream from the exchanger.

The proportional action will allow for the control of the flow-rate as a function of the distance between the temperature detected and the setpoint. The integral action, on the other hand, will act on the reaction speed of the system. L'azione integrale, invece, agirà sulla velocità di reazione del sistema.

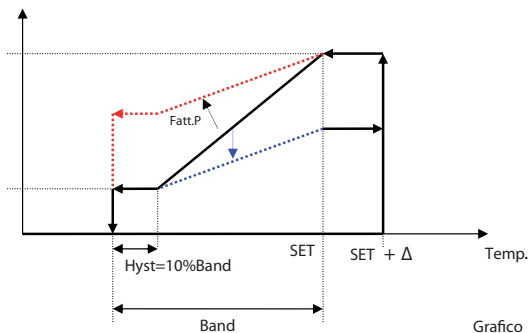

Fig. 7.d

As seen in the figure, increasing factor P (dashed red line) reduces sensibility to temperature variations, resulting in a decreased reduction request in correspondence to the same temperature variation. The integral contribution, on the other hand, reduces the request to a greater extent the longer the deviation from the control temperature setpoint remains.

• controllo TH:

This type of control is used to modulate the capacity (water flow-rate) with a temperature probe, installed in the return air, downstream from exchanger, and a limit humidity probe, usually installed downstream from the droplet separator.

In order to enable this configuration, a droplet separator is NECESSARY, otherwise there is a risk that the probe could get wet, thus constantly detecting humidity values close to the saturation point.

The humidity probe will further limit the maximum request.

TT CONTROL

This type of control is used to modulate the capacity (water flow-rate) with a temperature control probe and a temperature limit probe. The control probe is usually installed in the centre of the room and the limit probe in another "critical" point where the temperature must absolutely not be lower than a settable limit value.

TF CONTROL (T + air flow/flow-rate limit)

This type of control is used to modulate the capacity (water flow-rate) with a temperature control probe and an air flow modulator, which can correspond to:

- the modulating opening signal of the recirculation air lock;
- the modulating signal from the fan

In this case, the limit signal will function as:

- a temperature limit signal, in the event of a modulating signal from the fan
- a humidity limit signal, in the event of a air lock opening modulating signal.

PH/PT/PF CONTROL

The modulation of the capacity is proportional to an external control signal and limited based on the measured value of the temperature, humidity or flow limit signal.

This is the typical configuration when the control is entrusted to a Building Management System that generates a control signal.

• P Control

This control is like the PH control, but without humidity limit probe. The following is a graphic with proportional control.

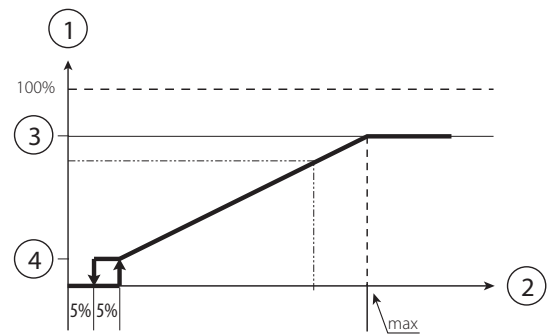

Fig. 7.e

Key:

1. production
2. external request
3. maximum production
4. minimum production

CH/CT/CF CONTROL

This control mode corresponds to the ON/OFF operation, from a non-powered external contact (for example, a humidistat).

The capacity will therefore be the maximum set or nothing (no modulation) according to the status of the external contact and limited based on the limit signal.

See sections TT/TH/TF for more information regarding limit signals.

C CONTROL

This control corresponds to the ON/OFF operation mode without any limit probe. The request directly follows only the control contact.

NOTE: Whenever the activation signal from the recovery unit is a digital signal, the control contact will NOT be the same signal; they will be two distinct signals.

LIMIT PROBE

In the following graphics, the first represents the limitation of the maximum production with a temperature limit probe or an activation signal from the IEC ventilator. The second graphic, on the other hand, represents the case in which the limit probe is a humidity probe or an opening signal from the recirculation air lock.

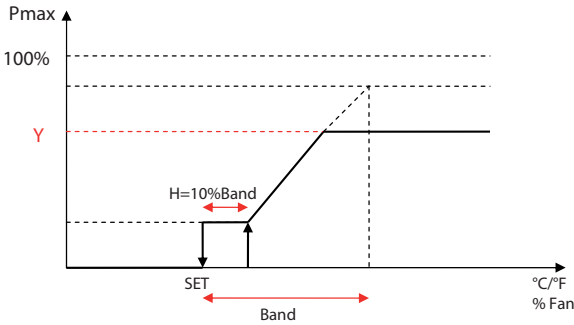

Fig. 7.f

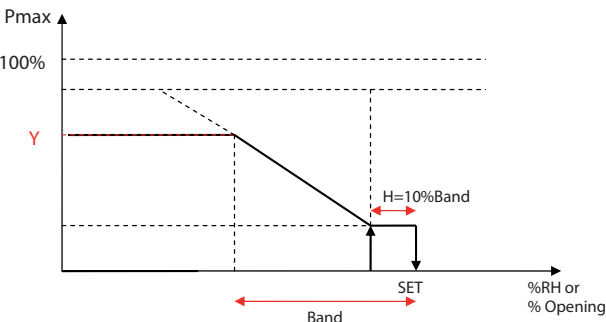

Fig. 7.g

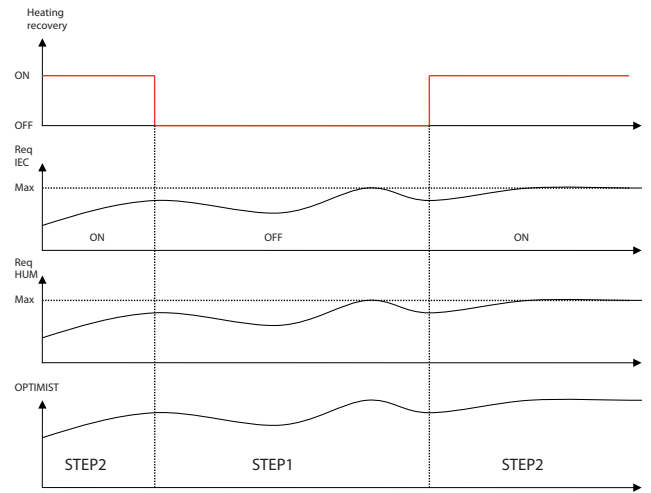

Fig. 7.h

7.3 Humidification + Evaporative Cooling

The optiMist humidifier provides the ability to configure the outlet humidity control and the indirect evaporative cooling contribution control at the same time.

! ATTENTION: the operation of the two zones is mutually exclusive; the two zones, therefore, will never work at the same time.

- Selecting the active zone will depend upon:
- a) the priority assigned by digital input ID4 (closed contact for I.E.C., open contact for Humidification) [see section 3.x];
 - b) the current request for humidity/cooling.

Once the priority is selected, the system will evaluate if the priority zone will be in request, otherwise it will satisfy the request from the other zone.

The following examples shows the case where the priority is set for indirect evaporative cooling, with step 1 dedicated to humidification and step 2 to indirect cooling.

8. STARTING AND USER INTERFACE

Before starting the humidifier check:

-  water and air connections (chap. 2). In the event of water leaks do not start the humidifier before having resolved the problem;
- electrical connections (cap. 3)

8.1 Starting



8.2 Stopping

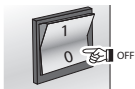

Note: if the system is stopped for an extended time, open the valve at the end of the water line to assist drainage. If the system is fitted with drain solenoid valves at the end of the line (optional), this is done automatically.

8.3 First start-up (setting the language)

On power-up, the following screen is displayed:

Display	Description	Range	Def.	UoM
LANGUAGE				
Language	View current languages	English, Italiano, Deutsche, Espanol, Français		
ENTER to change, ESC to confirm	Pressing ENTER changes the chosen language, ESC exits to the next page			

Tab. 8.a

Legenda: Display = visualized on display; Def. = default; UoM = unit of measure

Note: The language can also be changed from the maintenance menu (maintenance menu > system info > language).

8.4 Wizard

At machine start-up, once the language is selected, a guided procedure (Wizard) is accessed which allows the installer to configure the principle machine operations.

The following lists the parameters that can be configured using this procedure:

- Unit of measure.
- Number of steps and respective nominal flow-rates
- Type of installation (only Humidification, only Evaporative Cooling, Humidification+ Evaporative Cooling).
- Configuration of the control inputs (with indications for verifying the fitness of the electrical connections).

Once this procedure is correctly completed, the machine will be ready to operate.

Access to the Wizard section will then be possible through the Installer Menu - Wizard, or when the machine is restarted (if the option "Show Wizard at start-up" has not been disabled).

8.5 Keypad

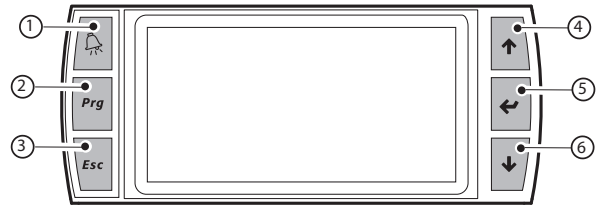

Fig. 8.a

button	function
1	alarm list active alarms and reset any alarms present
2	PRG return to the "main" screen from the "main" screen access the main menu
3	ESC return to the previous screen/display
4	UP circular navigation inside the menus, the screens, the parameters and the values of the parameters from the "main" screen, access an "INFO menu"
5	ENTER select and confirm (like the "Enter" key on a computer keyboard) from the main menu, access the "SET" screen
6	DOWN circular navigation inside the menus, the screens, the parameters and the values of the parameters from the main screen, access the warning screens

Tab. 8.b

8.6 "Main" screen

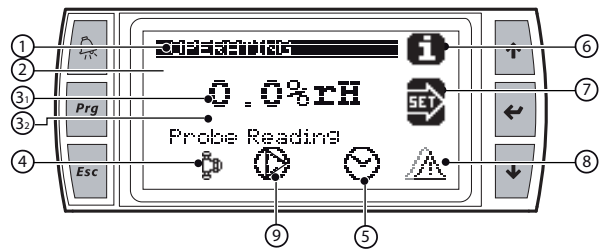

Fig. 8.b

Button	Function
1	Zone status description (*)
2	Main control signal from the active zone.
3	Limit signal reading from the active zone.
4	Active work zone (humidification or indirect evaporative cooling)
5	Display: • pump in operation (flashing triangle in the centre of the icon); • pump not in operation (triangle not flashing in the centre of the icon, empty)
6	Status of the atomising nozzles: • atomising nozzles in operation; • atomising nozzles not in operation; • zone disabled
7	Scheduler set
8	Accesses the "Warnings" screen which contains the alarm messages that have been received (DOWN key)
9	Accesses the "SET" screen (ENTER key)
10	Accesses the "INFO" screen (UP key)

Tab. 8.c

(*) Types of descriptions:

1. < OFF FROM SCHEDULER / OFF FROM REMOTE / OFF FROM KEYPAD / OFF SUPERVISOR / OFF FLOW SWITCH / OFF BACKUP / ALARM / WARNING / FILLING / WASHING / OPERATING >

8.7 "INFO" screens

Series of read-only screens for displaying the main humidifier status values. To access, press UP from the "Main" screen. There are three "INFO" screens; to move from one screen to the next, press UP or DOWN. Press ESC to return to the "Main" screen.

Display	Value and notes	UoM
Zone info 1/2		
Request	Capacity request	kg/h
Production	Current humidifier capacity	kg/h
Aux probe	Display value read by auxiliary probe (not control, display only)	%rH or °C/°F
1 L 2	See note below (*)	
F Hr Pr	See note below (*)	
D	See note below (*)	
Date and time	Date and time	

Tab. 8.d

(*) The display shows a table where the columns represent the 2 capacity modulation steps and the rows contain the following information:
 Row F - the symbol "→" is displayed if the branch is atomising, otherwise "-" is shown
 Row D - the symbol "↓" appears if the branch is draining (valve open), otherwise "-" is displayed if the drain valve is closed.
 In column Hr, if the heat recovery is active, the symbol "☐"; otherwise "-".
 In column Pr, the priority choice will be shown: the symbol "☼" if priority is given to Humidification, "☁" if given to evaporative cooling.

For example, the table may be as follows:

	1	2	L		Hr	Pr
F	-	→	-			
D	-	-	-		☐	☼

This indicates that branch 2 is active, heat recovery is active and priority is given to evaporative cooling.
 Another example may be as follows:

	1	2	L		Hr	Pr
F	-	-	-			
D	↓	-	-		☐	☁

This indicates that no branch is active, the drain valve for branch 1 is open, the heat recovery unit is off and priority is given to humidification.

Using the UP and DOWN keys accesses the Info 2/2 screen.

Display	Value and notes	UoM
Zone info 2/2		
Pump Press.	outlet pressure	bar / psi
Main probe	Displays the value read from the main control probe (zone not active)	°C/°F/%rH/%
Limit probe:	Displays the value read from the limit probe (zone not active)	°C/°F/%rH/%
Temp.bypass	Displays the value read by the bypass temperature probe	°C/°F
Prod. max. red. HUM	Maximum production due to reduction for high pressure	kg/h-lb/h
Prod. max. red. IEC	Maximum production due to reduction for high pressure	kg/h-lb/h

Tab. 8.e

Whenever the optiMist humidifier is configured to control the section dedicated to Evaporative Cooling (IEC) and the heat recovery activation is giving by an analog signal, the value of that signal will be shown in screen Info 3/3.

8.8 "SET" screen

This is used to set the main values for the humidifier.

From the main screen press:

- ENTER to access the menu;
- ENTER to move from one value to another;
- UP and DOWN to modify the selected value;
- ENTER to confirm and go to the next value.

Display	Value and notes	Default	UoM
SET HUM			
SETpoint	Humidity setpoint	50%rH	%U.R
Funzionamento	Auto (in control) or OFF	Auto	
Prod. max	Maximum capacity that can be generated, as a percentage of the nominal capacity	100	%
Banda prop.	Proportional Band (modulation)	5	%
Set point lim	Temperature or humidity limit (limit probe)	90%rH or 20°C / 70°F	°C/°F o %U.R.
Banda prop. Lim.	Proportional band for the limit probe (modulation)	5	%
Abil. Pompa	Enable pump /Yes/No	Yes	

Tab. 8.f

Display	Value and notes	Default	UoM
SET I.E.C.			
SETpoint	Temperature setpoint	25°C / 77°F	°C/°F
Funzionamento	Auto (in control) or OFF [visible only if the Humidification zone is not configured]	Auto	
Prod.max	Maximum capacity that can be generated, as a percentage of the nominal capacity	100	%
Banda prop.	Proportional band	5°C/ 41°F	
Differenziale	Activation differential (only temperature control)	2°C/ 36°F	
Setpoint lim	Temperature, humidity or flow limit (limit probe)	90%rH or 20°C / 70°F	°C/°F o %U.R.
Banda prop. Lim.	Proportional band	5	%

Tab. 8.g

8.9 "Warnings" screen

The warning screen spontaneously displays messages generated by fixed events. One typical example is a lack of supply water, which generates an alarm but that, when supply pressure returns, is automatically reset and optiMist resumes operation: the reset alarm message will appear on the warning screen.

8.10 Main menu

To access press PRG from the main screen

Buttons:

- UP and DOWN: navigation inside the submenus, screens, and range of values and settings;
- ENTER: confirm and save the changes made;
- ESC: to go back (pressed more than once returns to the "Main" screen)

Menu tree

1. User	1. Alarm threshold 1/2 (Humidification)	Main probe threshold High alarm Low alarm Limit probe thresholds Alarm threshold Alarm delay		
	1. Alarm threshold 1/2 (Evaporating cooling)	Main probe threshold High alarm Low alarm Limit probe thresholds Alarm threshold Alarm delay		
	2. Clock	Hour Day Month Year Format Day of the week		
	3. Enable scheduler	Scheduler on/off Off and postpone sched.		
	4. Set scheduler	P1-1 P1-2 P2 P3 P4		
	5. Weekly scheduler	Monday Tuesday Wednesday Thursday Friday Saturday Sunday		
	2. Installer (password 77)	1. Pump menu	1. Pump Setting 1/2 (i)	Operation mode: flow-rate control High press. Low press.
			1. Pressurisation 2/2	Pressure threshold Pump speed
			2. Water supply 1/2	Low pressure probe Alarm delay Water treatment alarm logic Water treatment warning logic WTS relay logic
			2. Water supply 2/2	TEST PRESS. INLET Check time Retries every:
3. Special pump functions 1/2			FILLING Enable valve delay Duration Automatic washing Mode<only draining/ washing daily / periodic washing > Hour of the day / time Duration	
3. Special pump functions 2/2			Enable valve delay Valve delay Min Ton step	
2. Menu Zona		1. Config. Inputs 1/10	Installation type	HUMIDIFICATION
		1. Config. Inputs 2/10	Operation type Control Signal Signal Type Min Max Offset	
		1. Config. Inputs 3/10	Limit signal Signal Type Min Max Offset	
		1. Config. Inputs 4/10	EVAPORATIVE COOLING Operation type Control Signal Signal Type Min Max Offset	
		1. Config. Inputs 5/10	Limit signal Signal Type Type (only if flow limit) Min Max Offset	
		1. Config. Inputs 6/10	Heat recovery activation Min (*) Max (*) Offset (*) Ist: On Off (*) (*) only if heat recovery from ANALOGUE INPUT	
		1. Config. Inputs 7/10	Min (*) Max (*) Offset (*) Ist: On Off (*) (*) only if heat recovery from ANALOGUE INPUT	
		1. Config. Inputs 8/10	EVAPORATIVE COOLING Control Temperature P Factor Integral time	

2. Installer (password 77)	2. Menu Zona	1. Config. Inputs 9/10	Rack probe Enable Signal type Min Max Offset Red. Prod.
		1. Config. Inputs 10/10	Rack probe Set point Warning differential Band
		2. Distribution system (note i)	Steps: Nominal (HUM) Nominal (IEC) Min production Hum. Min production I.E.C.
		3.Special zone functions 1/4	Al. relay logic Flowswitch logic Language Show languages list at startup?
		3.Special zone functions 2/4	optiMist as backup Rotation (*) Rotation time (hours) (*enabling available only if backup is not yet set
		3.Special zone functions 3/4	Enable winterisation on shutdown Start manually (*) (* only if winterisation enabled
		3.Special zone functions 4/4	Digit new installer password
		4. Supervision 1/2	Id for BMS Baud rate Protocol type
		4. Supervision 1/2	On/off by supervisor Reg. by superv. Hum. Reg. by superv. IEC
		5. External Alarms	Drop separator alarm logic
3. Wizard 1/10	Type:optiMist Model Unit of measure		
3. Wizard 2/10	Installation type		
3. Wizard 3/10	Number branches Nominal flow-rate Nominal flow-rate IEC		
3. Wizard 4/10	HUMIDIFICATION Operation type Control Signal Signal Type Min Max Offset		
3. Wizard 5/10	Limit signal Signal Type Min Max Offset		
3. Wizard 6/10	EVAPORATIVE COOLING Operation type Control Signal Signal Type Min Max Offset		
3. Wizard 7/10	Limit signal Signal Type Type (only if flow limit) Min Max Offset		
3. Wizard 8/10	Heat recovery activation Min (*) Max (*) Offset (*) Ist: On Off (*) (* only if heat recovery from ANALOG INLET		
3. Wizard 9/10	Connection control HUMIDIFICATION Main Limit EVAPORATIVE COOLING Main Limit		
3. Wizard 10/10	Show wizard at start-up Confirm data upon exiting Wizard		

Maintenance (password 77)	1. Reset conf	Restore default
	2. System info 1/3	Model:
		Flow-rate
		Supply
		Unit of measure
	2. System info 2/3	Bios (version / date)
		Boot (version / date)
		SW application code
		Version
		Date
	2. System info 3/3	New maintenance password
	3. Instantaneous readings	Main Humidification
		Humidification Limit
		Main IEC
		IEC Limit
		Heat recovery
	4. Manual procedure	AUX
		Request production zone
	5. System status info	Analog and digital input readings
		Analog and digital output writing
6. Hour gauge	Machine status	
	Pump hours	
	Total hours	
	Reset pump hours	
7. Alarm history	Reset data	
	No. xxx hour date	
	Alarm message	

Tab. 8.h

8.11 User menu

From the main screen press:

- PROG to access the main menu;
- ENTER to select and access the selected menu;
- UP/DOWN to move between the submenus;
- ENTER to enter the submenus
- ENTER to select the parameter and move between the parameters;
- UP/DOWN to modify the parameter;
- ENTER to confirm selected parameter and go to the next parameter;
- ESC to return to the previous menu.

To navigate inside the screens:

- UP or DOWN to modify the value (within the options/range),
- ENTER to confirm and move the cursor to the next value
- ESC to return to the installer menu.

User menu screens:

1. User	1. Alarm threshold
	2. Clock
	3. Enable scheduler
	4. Set scheduler
	5. Weekly scheduler
	6. Scheduled set point

Submenu: 1. Alarm threshold

If the zone dedicated to humidification is configured, the following screen appears:

Display	Description	Range	Def.	UoM
Main probe threshold				
Alarm high	High humidity alarm threshold	0...100%rH	100 %rH	%rH
Alarm low	Low humidity alarm threshold	0...100%rH	0 %rH	%rH
Limit probe thresh.				
Alarm high	High humidity/temperature limit alarm threshold	0...150°C/°F	100 %rH	°C °°F
		o 0...100%rH		o %rH
Alarm delay	Alarm signalling delay	0...99	1	min

Tab. 8.i

Where there is a zone dedicated to evaporative cooling, the following screen will also appear:

Display	Description	Range	Def.	UoM
Main probe threshold				
Alarm high	High temper. alarm threshold	40 °C	100 %rH	%rH
Alarm low	Low temper. alarm threshold	20 °C	0 %rH	%rH
Limit probe thresh.				
Alarm high	High humidity/temperature limit alarm threshold	40 °C	100 %rH	°C °°F
				o %rH
Alarm delay	Alarm signalling delay	0...99	1	min

Tab. 8.j

Submenu: 2. Clock

Display	Description	Range
Hour	Setting the time on the internal clock	
Day	Setting the day on the internal clock	
Month	Setting the month on the internal clock	
Year	Setting the year on the internal clock	
Format	Setting data format	dd/mm/yy - mm/dd/yy
Week day	Day of the week corresponding to the date	Monday to Sunday

Tab. 8.k

Submenu: 3. Enable scheduler

Display	Description	Range	Def.	UoM
Enable scheduler				
Scheduler ON/OFF	Enable scheduler	NO/YES	NO	
Delay scheduler:	Temporarily shut down the optiMist which will restart after _____ minutes	0...999	0	min

Tab. 8.l

Submenu: 4. Set scheduler

Note: the screen is visible if "scheduler ON/OFF" has been enabled (see enable scheduler screen).

Setting the intervals for the operation of the humidifier over one day (24h):

Display	Description	Ora ON	Ora OFF
P1-1	First P1 interval	9:00	13:00
P1-2	Second P1 interval	14:00	21:00
P2	First P2 interval	8:00	18:00
P3	Time slot always ON	ON always	
P4	Time slot always ON	OFF always	

Tab. 8.m

Parameters P1...P4 can be used to set how many times atomised water production is enabled or disabled over a 24 hour period.

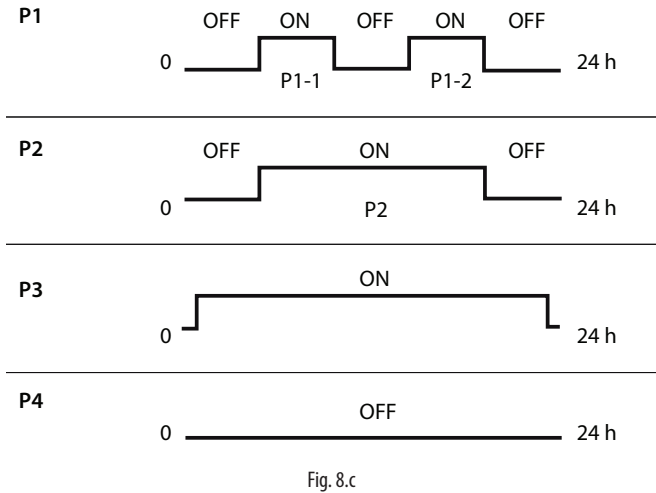

P1	2 daily time slots ON
P2	Single time slot ON
P3	always ON
P4	always OFF

Submenu: 5. Weekly scheduler

Note: the screen is visible if "scheduler ON/OFF" has been enabled (see enable scheduler screen).

Setting of the weekly operation of the humidifier, using parameters P1...P4 (configured in the previous screen)

Display	Range
Monday	P1...P4
Tuesday	P1...P4
Wednesday	P1...P4
Thursday	P1...P4
Friday	P1...P4
Saturday	P1...P4
Sunday	P1...P4

8.12 Installer menu

From the main screen press:

- PRG to access the main menu;
- DOWN to move to the installer menu;
- ENTER to move to the password;
- UP/DOWN to enter the password "77"
- ENTER to access the selected menu;
- UP/DOWN to move between the submenus;
- ENTER to select the parameter and move between the parameters;
- UP/DOWN to modify the parameter;
- ENTER to confirm the selected parameter and go to the next parameter;
- ESC to return to the previous menu.

To navigate inside the screens:

- UP or DOWN to modify the value (within the options/range),
- ENTER to confirm and move the cursor to the next value
- ESC to return to the installer menu.

The installer menu is divided into four submenus

Display	Description
1. Pump menu	Contains the menus with the installer parameters corresponding to the pumping station
2. Zone Menu	Contains the menus with the installer parameters for the controlled zone (rack or distribution system for room)
3. Wizard	Contains the parameters for basic machine configuration.

Tab. 8.n

Submenu: 1. Pump Menu - 1. Pump Setting

Contains the menus with the installer parameters corresponding to the pumping station.

Display	Description	Range	Def.	UoM
PUMP SETTINGS				
Mode:	optiMist operating mode			
Flow-rate control				
High press.	Maximum modulation limit; activation threshold for the next modulation step	4..15 bar / 58...218 psi	15 bar / 218 psi	bar/psi
Low press.	Minimum modulation limit; deactivation limit for the modulation step	4..15 bar / 58...218 psi	4 bar / 58 psi	bar/psi

Tab. 8.o

Submenu: 1. Pump Menu - 2. Water supply

Display	Description	Range	Def.	UoM
WATER SUPPLY 1/2				
Low pressure probe. Alarm delay:	low pressure supply alarm signalling delay	0...999	60	S
Water treatment alarm logic	Water treatment inlet alarm logic	N.C, N.O.	N.C.	
Water treatment warning logic	Water treatment inlet Warning logic	N.C, N.O.	N.C.	

Tab. 8.p

Display	Description	Range	Def.	UoM
WATER SUPPLY 2/2				
TEST PRESS. INLET				
Check time	Water presence verification duration	0...999	15	s
Retries every	Delay before the next verification	0...999	15	s

Tab. 8.q

Submenu: 1. Pump Menu - 3. Special functions

Display	Description	Range	Def.	UoM
Special pump functions 1/2				
FILLING				
Enable	Enable filling	NO/YES	NO	
Duration	Filling duration	1 to 60	2	Min
AUTOMATIC WASHING				
Mode	automatic washing mode	only emptying/periodic/daily	only emptying	
Hour of the day	Washing activation schedule (only for daily washing)	00:00 to 23:59	0.00	hour: minute
Time	Interval between two washings (only for periodic washing)	1 to 120	24	hours

Tab. 8.r

Display	Description	Range	Def.	UoM
Special pump functions 2/2				
Enable valve delay	Enable delay in closing step	NO..YES	YES	
Valve delay	Delay in closing step	0..60	5	S
Min Ton step	Minimum ON time for one step (avoid surges)	0...9999	30	s

Tab. 8.s

Submenu: 2. Zone Menu - 1. Input configuration

Display	Description	Range	Def.	UoM
Config.Inputs 1/8				
Installation type	Operation mode selection	1) Evaporative Cooling, 2) Humidification, 3)Humidification+Evaporative Cooling	1) Evaporative cooling	

Tab. 8.t

Configuration of the control inputs for the zone dedicated to humidification is done through the following screens.

Display	Description	Range	Def.	UoM
Config.Inputs 2/8				
HUMIDIFICATION				
Operation type:	Set control type	Humidity Humidity+Limit Humid. Humidity+Temp. Limit External prop.Signal Prop.+Humid.Lim. Sign. Prop.+Temp.Lim.Sign. Contact On/Off Cont.On/ Off+Hum.Lim Cont.On/ Off+Temp.Lim		
Control Signal	Type of control signal [B1 analog inlet]	NTC, 0 to 135oh, 0-1V, 0-10V, 4-20mA,0-20mA		
Min:	Minimum control signal value	0 to 100	0	%rH/%
Max:	Maximum control signal value	0 to 100	100	%rH/%
Offset:	Probe reading correction offset	0 to 100	0	%rH/%

Tab. 8.u

Display	Description	Range	Def.	UoM
Config.Inputs 3/8				
HUMIDIFICATION				
Limit	Type of control signal [B2 analog inlet]	NTC, 0...135oh, 0-1V, 0-10V, 4-20mA, 0-20mA		
Min:	Minimum control signal value	0...100%rH/ -20...70°C	0% rH / -20°C	%rH/ °C-°F
Max:	Maximum control signal value	0...100%rH/ -20...70°C	100%rH / 70°C	%rH/ °C-°F
Offset:	Probe reading correction offset	0...100%rH/ -20...70°C	0	%rH/ °C-°F

Tab. 8.v

The configuration of the control inputs for the zone dedicated to evaporative cooling (IEC) is done through the following screens.

Display	Description	Range	Def.	UoM
Config.Inputs 4/8				
EVAPORATIVE COOLING				
Operation type:	Set control type	Temperature Temp.+Humid. Limit Temp.+Temp. Limit Temp.+Flow Limit Signal prop.external Sign.prop+Humid.Lim. Prop.+Temp.Lim.Sign. Prop.+FlowLim.Sign. Contact On/Off Cont.On/ Off+Humid.Lim. Cont. On/Off+TempLim. Cont. On/Off+FlowLim	External prop. sign.	
Control Signal	Type of control signal [B6] analog inlet]	NTC, 0 to 135oh, 0-1V, 0-10V, 4-20mA,0-20mA	0 to 10V	
Min:	Minimum control signal value	0 to 100% / -20°C to 70°C	0% / -20°C	% / °C-°F
Max:	Maximum control signal value	0 to 100% / -20°C to 70°C	100% / 70°C	% / °C-°F
Offset:	Probe reading correction offset	0 to 100% / -20°C to 70°C	0	% / °C-°F

Tab. 8.w

Display	Description	Range	Def.	UoM
Config.Inputs 5/8				
EVAPORATIVE COOLING				
Limit	Type of limit signal [B7 analog inlet]	NTC, 0...135oh, 0-1V, 0-10V, 4-20mA, 0-20mA		
Type	limit signal correspondence (only if flow signal)	Air lock or Fan	Air lock	
Min:	Minimum control signal value	0...100%rH/ -20...70°C	0	% / %rH/ °C-°F
Max:	Maximum control signal value	0...100%rH/ -20...70°C	100% - %rH o 70°C	% / %rH/ °C-°F
Offset:	Probe reading correction offset	0...100%rH/ -20...70°C	0	% / %rH/ °C-°F

Tab. 8.x

optiMist's operation as an evaporative cooling (IEC) system requires the indication of the activation of heat recovery. The next screen is dedicated to setting that signal.

Display	Description	Range	Def.	UoM
Config.Inputs 6/8				
EVAPORATIVE COOLING				
Heat recovery activation from:	Recovery signal origin selection	Digital or analog input or supervision contact	Digital contact	
Min:	Minimum control signal value	0 to 100%	0	%
Max:	Maximum control signal value	0 to 100%	100	%
Offset:	Probe reading correction offset	0 to 100%	0	%
Ist:	Hysteresis type selection (ONLY if analog input is selected)	Direct or inverse	direct	
On:	Hysteresis activation threshold (ONLY if analog input is selected)	0 to 99.9%	50	%
Off:	Hysteresis deactivation threshold (ONLY if analog input is selected)	0 to 99.9	0	%

Tab. 8.y

Display	Description	Range	Def.	UoM
Config.Inputs 7/8				
TEMPERATURE CONTROL				
P Factor:	proportional contribution reduction factor	1..99	1	
Integral time:	integration time	1 to 32767	60	S

Tab. 8.z

A temperature probe can be installed just before the distribution system in order to check that the temperature is optimal for correct absorption of the atomised water.

Display	Description	Range	Def.	UOM
Enable	Enables temperature measurement in the atomisation zone. When the temperature drops below the "rack temp. probe set point", a warning is displayed	Yes - No	NO	

Display	Description	Range	Def.	UOM
Probe type	Probe type	NTC 0-1 V 2-10 V 0-10 V 0-20 mA 4-20 mA 0-135 ohms 135-1k ohms PT1000	NTC	
Relative parameters	Correlate the min, max, and offset values	Min - Max - Offset	0.0 - 100.0 - 0.0	%°C/°F
Red. Prod.	Enables a reduction in production if the temperature in the atomisation zone falls below the "rack temp. probe set point", in proportion to the deviation from the ideal atomisation temperature	YES - NO	NO	

Tab. 8.aa

Display	Description	Range	Def.	UOM
Set point	Represents the minimum recommended temperature for atomisation	0.0 - 99.9	20.0	°C/°F
Band	Defines a modulation interval equal to "rack temp. probe set point" - "prop. band". Inside this interval, production will be modulated. Below this interval, production will be at the minimum. Above this interval, the production will resume as standard. Shown only if production reduction is enabled	0.0 - 99.9	3.0	°C/°F
Warning diff.	Defines the interval outside of which the warning message is cleared	0.0 - 99.9	5.0	°C/°F

Tab. 8.ab

It is possible to enable the configuration of an auxiliary temperature probe (view only, not control).

Display	Description	Range	Def.	UoM
Config.Inputs 8/8				
Aux Probe	Enable auxiliary probe	NO to °C/°F	NO	
AUX	Type of probe	NTC or PT1000	NTC	
Offset	Probe reading correction offset	-20 to +20°C/°F	0	°C/°F

Tab. 8.ac

Submenu: 2. Zone Menu – 2. Distribution system

Display	Description	Range	Def.	UoM
DISTRIBUTION SYSTEM				
Step number	step number	1 or 2	1	
Nominal	nominal flow-rate of the humidification rack	1 to Max pump flow-rate	0	kg/h / lb/h
Nominal IEC	nominal flow-rate of the IEC rack	1 to Max pump flow-rate	0	kg/h / lb/h
Hum. min production	minimum production for humidification	0 to 100	40	%
IEC min production	minimum production for IEC	0 to 100	40	%

Tab. 8.ad

Submenu: 2. Zone Menu - 3. Special functions

Display	Description	Range	Def.	UoM
SPECIAL FUNCTIONS 1/3				
Alarm relay logic	Logic of the alarm relay	N.O, N.C.	N.O	
Flow switch logic	Flow switch digital input logic	N.O, N.C.	N.C	
Language	User language choice	English, Italiano, Deutsche, Espanol, Français	English	
Show language choice at start-up	Show language choice in the first start-up screen	YES to NO	YES	

Tab. 8.ae

Display	Description	Range	Def.	UoM
SPECIAL FUNCTIONS 2/3				
optiMist as backup:	Select enabling of this cabinet as a backup cabinet	NO, ID8 (life sign control other cabinet from digital input), BMS	N.O	
Rotation	Enable rotation (settable only if the option "Backup optiMist" is not enabled)	DISABLE, ENABLE	DISABLE	
Rotation time	Every how many hours the active pump station changes	0 to 8	1	hours

Tab. 8.af

Display	Description	Range	Def.	UOM
Humid and lim. probe alarms with pump ON:	Enable probe alarms with pump running	Yes, No	No	
Check alarm presence activation delay	Duration of the delay for alarm activation	0-60	5	min

Display	Description	Range	Def.	UOM
Enable winterisation on shutdown	Enable the winterisation function automatically on each shutdown	Yes, No	No	
Start manually	Start the winterisation function manually	Yes, No	No	

Tab. 8.ag

The minimum/maximum rack flow-rate calibration function is used to modify the minimum/maximum frequency of the inverter, so as to optimise water pressure/flow-rate based on the system's minimum/maximum set point.

When the calibration function is started, the frequency of the inverter automatically goes to the minimum/maximum default values, and the pressure reached is shown on the display.

To obtain a different pressure value, the frequency of the inverter can be gradually adjusted using the offset parameter, while viewing the pressure on the display.

Display	Description	Range	Def.	UOM
Enable min/max rack calibration	Enable maximum and minimum rack capacity calibration function	Yes, No	No	

Tab. 8.ah

Display	Description	Range	Def.	UOM
Start	Start minimum humidification rack flow-rate calibration	Yes, No	No	
Offset	Inverter offset setting in hertz		0	Hz
Open steps Production	Display the number of open steps rack flow-rate	0-2		Hz
Pressure	Display water pressure at minimum rack flow-rate			bar

Tab. 8.ai

Display	Description	Range	Def.	UOM
Start	Start maximum humidification rack flow-rate calibration	Yes, No	No	
Offset	Inverter offset setting in hertz		0	Hz
Open steps	Display the number of open steps	0-2		
Production	Display inverter hertz at minimum rack flow-rate			Hz
Pressure	Display water pressure at maximum rack flow-rate			bar

Tab. 8.aj

Display	Description	Range	Def.	UOM
Start	Start minimum humidification rack flow-rate calibration for Indirect Evaporative Cooling (IEC)	Yes, No	No	
Offset	Inverter offset setting in hertz		0	Hz
Open steps	Display the number of open steps	0-2		
Production	Display inverter hertz at minimum rack flow-rate			Hz
Pressure	Display water pressure at minimum rack flow-rate			bar

Tab. 8.ak

Display	Description	Range	Def.	UOM
Start	Start maximum humidification rack flow-rate calibration for Indirect Evaporative Cooling (IEC)	Yes, No	No	
Offset	Inverter offset setting in hertz		0	Hz
Open steps	Display the number of open steps	0-2		
Production	Display inverter hertz at minimum rack flow-rate			Hz
Pressure	Display water pressure at maximum rack flow-rate			bar

Tab. 8.al

Display	Description	Range	Def.	UoM
CHANGE PASSWORD				
Insert new installer password	Change installer password	0000 to 9999	77	

Tab. 8.am

Submenu: 2. Zone Menu - 4. Supervision

Display	Description	Range	Def.	UoM
CONFIG.SUPERVISION 1/2				
Id for BMS:	Supervision address selection	NO, ID8 (life sign control other cabinet from digital input), BMS	N.O	
Baudrate:	communication speed between the pCO and the supervisory system	1200,2400,4800, 9600,19200	19200	bps
Protocol type	Type of communication protocol	Carel, Modbus, Lon, RS232, WinLoad	Carel	hours

Tab. 8.an

Display	Description	Range	Def.	UoM
CONFIG.SUPERVISION 2/2				
On/Off from Superv.	Enable on/off from supervision	NO,YES	NO	
Control from Superv (Humid)	Enable control from supervision (Humidification if Humidification +IEC configuration)	NO,YES	NO	
Control from Superv IEC	Enabled control from IEC supervision	NO,YES	NO	

Tab. 8.ao

Submenu: 2. Zone Menu - 5. External Alarms

Display	Description	Range	Def.	UoM
External Alarms				
Droplet separator alarm logic	Droplet separator differential pressure switch alarm input logic	N.O. = (normally open) when connecting as described in the previous paragraphs, optiMist will show the Water treatment alarm if the connection is interrupted or, N.C. = (normally closed) when connecting as described in the previous paragraphs, optiMist will show the Water treatment alarm if the connection is not interrupted (contact closed)	N.C	

Tab. 8.ap

Submenu: 3. - Wizard

In this section, which can be accessed on start-up or through the Installer menu, the fundamental machine start-up parameters can be set. The screens in this section, recall the parameter settings mainly covered in the sections "Input configuration" and "Distribution System" shown previously.

8.13 Maintenance menu

⚠ Attenzione: le operazioni descritte in questo menu devono essere esclusivamente eseguite da personale qualificato.

From the main screen press:

- PRG to access the main menu;
- DOWN to move to the installer menu;
- ENTER to move to the password;
- UP/DOWN to enter the password "77"
- ENTER to access the selected menu;
- UP/DOWN to move between the submenus;
- ENTER to select the parameter and move between the parameters;
- UP/DOWN to modify the parameter;
- ENTER to confirm the selected parameter and go to the next parameter;
- ESC to return to the previous menu.

Installer menu screens:

Display
1. Reset conf
2. System info
3. Instantaneous readings
4. Manual procedure
5. System status info
6. Hour gauge
7. Alarm history

Submenu: 1.Reset conf

Display	Description	Range	Def.
Reset config.			
Reset default:	Activating recalls the default factory settings	NO,YES	NO
Set model	Setting the machine model	All machine models available	The same model shown on the cabinet label

Tab. 8.aq

Submenu: 2. System info

Display	Description	Range	Def.	UoM
MACHINE INFO 1/2				
Model	View machine model	All machine models available	The same model shown on the cabinet label	
Flow-rate	Nominal flow-rate of the pump	50, 100, 200, 400, 800, 1000 [kg/h]	flow-rate in according with the pump flow-rate	kg/h - lb/h
Voltage	Voltage supply	230V 50Hz, 230 60Hz	230V 50Hz if model EC***DH**0, 230V 60Hz if model EC***DH**U	
Unit of measure	Setting unit of measure	International, Imperial	International if model EC***DH**0, Imperial if model EC***DH**U	

Tab. 8.ar

Display	Description	Range
SYSTEM INFO 2/2		
Boot	Boot data and version	
Bios	Boot data and version	
Code	Software code loaded	FLSTDMOPTF
Version	Software version loaded	
Date	Compilation date of loaded software	

Tab. 8.as

Display	Description	Range	Def.	UoM
CHANGE PASSWORD				
Insert new installer password	Change Maintenance password	0000 to 9999	7683	

Tab. 8.at

Submenu: 3. Instantaneous readings

Display	Description	Range	Def.	UoM
INSTANTANEOUS READINGS 1/2				
Main (Humidification)	View signal read by humidification main input, B1			
Humid. Limit	View signal read by humidification limit input, B2			
AUX	View signal read by auxiliary temperature input B5			

Tab. 8.au

Display	Description	Range	Def.	UoM
INSTANTANEOUS READINGS 2/2				
Main IEC	View signal read by IEC main input [B6]			
IEC Limit	View signal read by IEC limit input, [B7]			

Tab. 8.av

Submenu: 4. Manual procedure

Display	Description	Range	Def.	UoM
Manual procedure				
Request production zone	Set the capacity % that the system must generate.	0...100	0	%
Manual controls to all I/O	Manual setting of the optiMist outputs and inputs			

Tab. 8.aw

Submenu: 5. System status info

Display	Description	Range	Def.	UoM
SYSTEM STATUS INFO				
System status	Current machine status	Standby empty, Standby full, production, washing, slowing, initialisation		

Tab. 8.ax

Submenu: 6. Hour gauge

Display	Description	Range	Def.	UoM
HOURL GAUGE				
Pump hours:	Pump operation time	0 to 999999	0	hours
Total hours:	Machine life in hours	0 to 999999	0	hours
Reset hours	Reset pump hour counter	YES, NO		
Last reset date:	Last pump hour reset date:	dd/mm/yy	Last model setup date	

Tab. 8.ay

Submenu: 7. Alarm history

Display	Description	Range	Def.	UoM
ALARM HISTORY				
No. xxx hour date	Succession of screens containing the progressive number of alarms detected, the hour and date saved.			
Alarm message				

Tab. 8.az

9. TABLE OF ALARMS

Message displayed	Cause	Solution	Reset	Alarm status	Action	 symbol	Notes
Water Treatment System alarm	Dig. input Id6 open, check any water treatment unit anomalies	Close dig. input ID6 with a jumper, if the alarm disappears, check the water treatment system: if the alarm persists, replace the controller	automatic	active	stop production	on	
Water Treatment System warning	Digital input ID7 open/closed (check logic): verify water treatment system anomaly	Close dig. input ID7 with a jumper, if the alarm disappears, check the water treatment system: if the alarm persists, replace the controller	automatic	not active	stop signalling	on	
Inlet line low pressure alarm	Low water pressure inlet	check supply circuit, water supply pressure and if inlet filter is clogged	automatic	not active	Stop production	on	check inlet pressure three times before generating next alarm (LP Test)
High bypass temperature alarm	excess water recirculation in bypass	check operating temperature (surrounding ambient air and water); check that the pressurised water distribution system is not blocked so as to cause water recirculation in the pump.	automatic	not active	signal only + opening of cabinet drain valve for 10 s ?*	on	* make sure there is no LP alarm from the probe during these 10s.
High bypass temperature alarm	excess water recirculation in bypass, warning active for 60s	check operating temperature (surrounding ambient air and water); check that the pressurised water distribution system is not blocked so as to cause water recirculation in the pump	automatic	active	Stop production	on	
Inverter VFD alarm	inverter fault	check the status of the inverter and replace if necessary	Note*	active	Stop production	on	* automatic reset on the inverter control depends on the type of alarm, see chapter 7 inverter manual
Low pump cabinet temperature alarm	water inlet temperature less than 5°C	heat supply water or the cabinet with a suitably rated heater*	automatic	active	Stop production	on	* possibility of activating the defrost
Droplet separator clogged alarm	droplet separator clogged	check the status of the droplet separator(s)	manual	active	Stop production	on	* signal given by a differential pressure switch that sees an upstream-downstream pressure difference for the droplet separator. When there are 2 droplet separators (Humidification+HEC), 2 pressure switches will be connected in series. P selectable, delay selectable
High pressure warning from pressure probe	outlet pressure greater than 20 bars	check bypass valve calibration	automatic	active	signal only	on	* before arriving at 20 base, the "Auto-tuning" procedure causes the system to operate at a max of 15.5 bars.
Distribution system maintenance request warning	the flow-rate is 40% lower in comparison to the MAX production set.	The SW continues auto-tuning automatically Check if the distribution system is clogged	automatic	not active	signal only	on	
Low pressure warning from pressure probe	outlet pressure less than 1 Bar*	check tightness of outlet water circuit	manual	active	Stop production	on	* threshold settable by parameter
Pressure probe broken or disconnected alarm	pressure probe broken or disconnected	check connection and operation of the pressure probe	manual	active	Stop production	on	* active only if configured
Main probe (Humidification) broken or disconnected alarm	main probe disconnected or broken	check connection and operation of the main probe	manual	active	Stop production	on	* active only if configured
Secondary probe (Humidification) broken or disconnected alarm	secondary probe disconnected or broken	check connection and operation of the secondary probe	manual	active	Stop production	on	* active only if configured
Main probe (IEC) broken or disconnected alarm	main probe disconnected or broken	check connection and operation of the main probe	manual	active	Stop production	on	* active only if configured
Secondary probe (IEC) broken or disconnected alarm	secondary probe disconnected or broken	check connection and operation of the secondary probe	manual	active	Stop production	on	* active only if configured
Auxiliary probe broken or disconnected alarm	auxiliary probe disconnected or broken	check connection and operation of the auxiliary probe	manual	not active	signal only	on	* active only if configured

Message displayed	Cause	Solution	Reset	Alarm status	Action	 symbol	Notes
Clock fault alarm	backup battery completely discharged or general clock fault	replace/repair electronic controller	Note*	not active	Stop production	off	* switch the unit off to repair or replace the electronic controller
Temperature bypass probe faulty or disconnected alarm	bypass temperature probe disconnected or broken	check connection and operation of the probe	manual	active	Stop production	on	
High humidity alarm (Humidification)	value measured by the main probe is greater than the humidity alarm threshold	check the parameter setting	manual	not active	signal only	on	
Low humidity alarm (Humidification)	value measured by the main probe is less than the humidity alarm threshold	check the parameter setting	manual	not active	signal only	on	
Limit probe high humidity alarm (Humidification)	value measured by the limit probe is greater than the humidity alarm threshold	check the parameter setting	manual	not active	signal only	on	* Active only if limit probe is present and set to humidity
High temperature main probe (IEC) alarm	value measured by the main probe is greater than the humidity alarm threshold	check the parameter setting	manual	not active	signal only	on	
Low temperature main probe (IEC) alarm	value measured by the main probe is less than the humidity alarm threshold	check the parameter setting	manual	not active	signal only	on	
High humidity/temperature limit alarm (IEC)	value measured by the limit probe is greater than the humidity alarm threshold	check the parameter setting	manual	not active	signal only	on	* Active only if limit probe is present and set to humidity
Rack capacity not set alarm	Wizard did not complete correctly. One or more rack capacities are set to zero.	check the parameter set by the Wizard or the Installer menu	automatic	active	Stop production	on	* not visible during the Wizard
Alarms: Heat recovery activation from analog input signal broken or disconnected	Value outside of range (generally -9999 or +9999)	Check electrical connection	manual	not active	Stop production *	on	* only IEC production
Low rack temperature	The temperature measured on the rack is lower than the set threshold	Check the environmental conditions near the rack, or set a higher threshold	Manual	Active	Display only	on	If reduction in production due to low rack temperature is enabled (screen Bbc05), current production is reduced based on the measured temperature

Tab. 9.a

10. WIRING DIAGRAMS

10.1 optiMist wiring diagram (EC*****0)

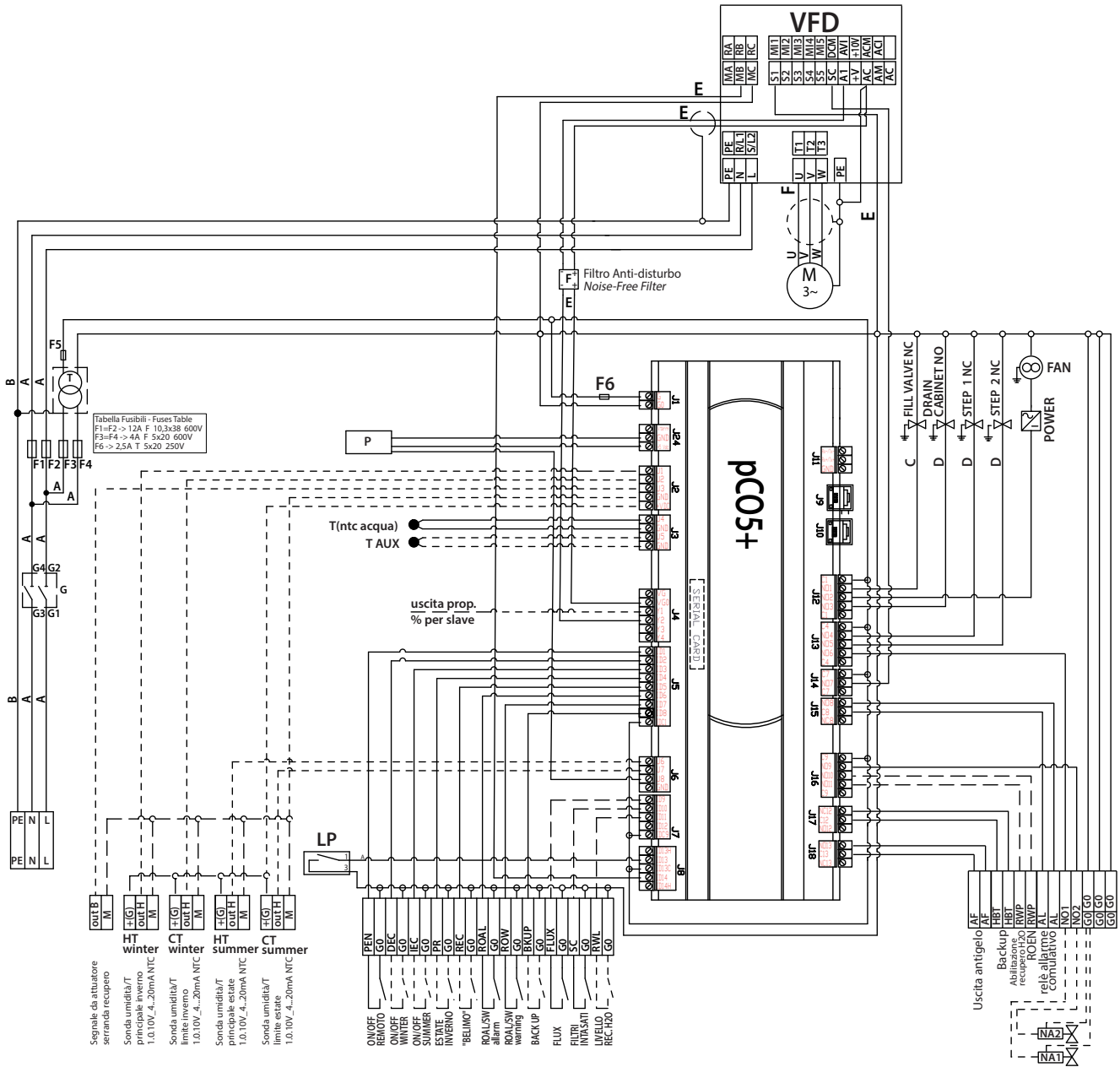

Fig. 10.a

NOTICE: for all of the details concerning the inverter, see the specific manual.

10.2 optiMist UL version wiring diagram (EC*****U)

installatore

utente

assistenza

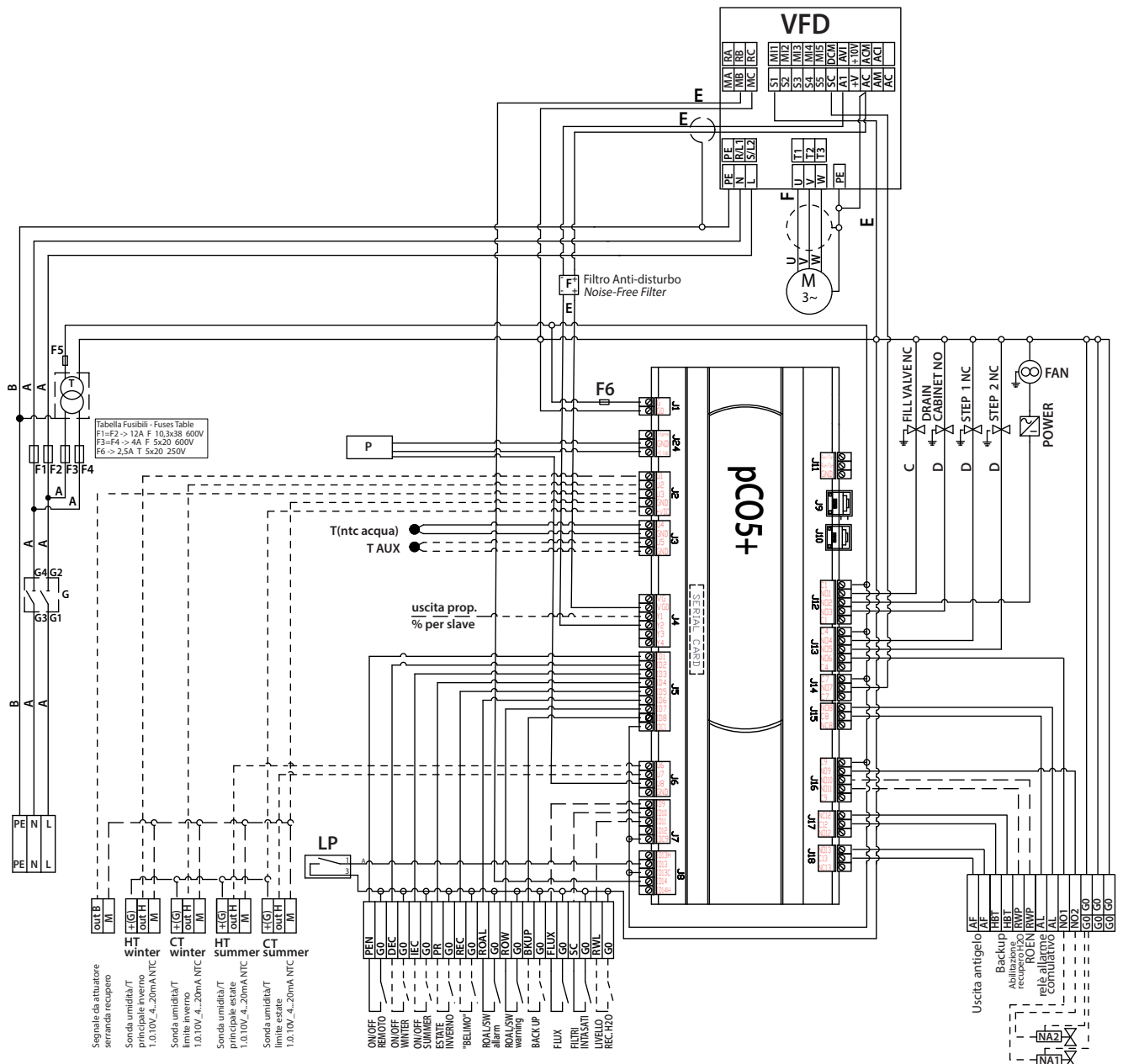

Fig. 10.b

NOTICE: for all of the details concerning the inverter, see the specific manual.

11. STARTUP

11.1 Startup

!Attention: before proceeding, make sure the unit is not connected to the mains.

Once the distribution system is assembled and the pumping station is installed, perform the operations listed below:

- Connection characteristics for connecting the water line to the optiMist water inlet: G3/4" f;
- Connect a drainpipe to the discharge solenoid valve at the pipe coupling, G3/4" f
- Connect the connection pipe(s) between the cabinet, G1/2" f and the distribution system G1/2" f
- of the pressurized water outlet of the pump towards the lower orifice
- connect the control signals and check that the control settings are compatible;
- Connect the discharge solenoid valve to the related clamps;
- Connect the electric supply cable to the appropriate clamps L, N, PE;
- Open the manual water valve upstream of the cabinet;
- Set the knife switch to position "1";
- At this point, voltage can be added using the external power switch;
- Activate the system using the control contact (Ref. par. 3.2);
- Check for any water leaks in the water circuit.

12. MAINTENANCE AND REPLACEMENT PARTS

12.1 Maintenance procedures

Since the optiMist humidification system does not require special maintenance in general, it is best to regularly perform systematic preventative maintenance.

The interval depends on the water quality: the more salts or impurities in the water, the more frequently the inspections must be performed.

Components to check inside the cabinet:

- Check the water inlet manometer pressure value
- Check and clean the water filter inside the cabinet.
- Check the water tightness of the corrugated stainless steel pipes inside the cabinet.
- Pump: check for leaks or drips

Water lines:

- Check the tightness of the seals on the connection pipes between the Cabinet and Rack.

Distribution system:

- Check the condition of the nozzles; clean or replace if necessary.
- Check the tightness of the connections whether threaded or compression

Droplet separator:

- Check for clogging in the separator

12.2 Replacement parts

Replacement parts for cabinet:

P/N	Description
MCKDSVWC00	N.O. water drain solenoid valve kit
ECKFSV0000	N.C. water fill solenoid valve kit
MCKFSVBC00	steps valve kit (optional)
ECKMA10000	pressure gauge 0 to 12 bars, glycerine
ECKMA25000	pressure gauge 0 to 25 bars, glycerine
ACKPS00000	pressure switch kit
UAKRID00000	water pressure reducer kit, EC050-400
ACKR100000	water pressure reducer kit, EC800-1K0
ECKP000500	pump kit 50 l/h with elastic coupling
ECKP001000	pump kit 100 l/h with elastic coupling
ECKP002000	pump kit 200 l/h with elastic coupling
ECKP004000	pump kit 400 l/h with elastic coupling
ECKP008000	pump kit 800 l/h with elastic coupling
ECKP010000	pump kit 1000 l/h with elastic coupling
ECKM253F50	motor kit 0.25 kW 3~ 4 poles 230 V 50 Hz CE for EC005/010****0
ECKM373F50	motor kit 0.37 kW 3~ 4 poles 230 V 50 Hz CE for EC020/040****0
ECKM753F50	motor kit 0.75 kW 3~ 4 poles 230 V 50 Hz CE for EC080/100****0
ECKM253F60	motor kit 0.25 kW 3~ 4 poles 230 V 60 Hz UL for EC005/010****U
ECKM373F60	motor kit 0.37 kW 3~ 4 poles 230 V 60 Hz UL for EC020/040****U
ECKM753F60	motor kit 0.75 kW 3~ 4 poles 230 V 60 Hz UL for EC080/100****U
ECKVFD0250	EC005/010**** - inverter 0.25 kW 230 V
ECKVFD0400	EC020/040**** - inverter 0.40 kW 230 V
ECKVFD0750	EC080/100**** - inverter 0.75 kW 230 V
URKTR20000	100 VA transformer
ECKPCO3000	pCO3 medium for EC****
ECKFUSE000	fuse kit
SPKT0043R0	pressure probe
ECKVESS050	5" vessel filter kit
ECKFILT050	5" filter kit
NTC030WH03	NTC temperature probe
1309549AXX	temperature-controlled valve
URKFANS000	cooling fan for cabinet electrical part
ECKHLPS000 (**)	stainless steel pump intake and outlet hose kit
ECKHLPSF00 (*)	hose kit for EC005/010/020/040****
ECKHLPSF10 (*)	hose kit for EC080/100****
PGDE000F00	display

Tab. 12.a

(*) from rev. 1.130

(**) up to rev. 1.030

Rack replacement parts kit

P/N	Description
ECKDSV0000	N.O. water drain solenoid valve kit
ECKDMV0000	mechanical drain valve kit
ECKN0505D0	kit of 50 nozzles, 6 l/h 15 bars
ECKN0501D0	kit of 10 nozzles, 6 l/h 15 bars
ECKN050500	kit of 5 nozzles, 6 l/h 15 bars
ECKN050000	kit of 1 nozzle, 6 l/h 15 bars
ECKN0405D0	kit of 50 nozzles, 5 l/h 15 bars
ECKN0401D0	kit of 10 nozzles, 5 l/h 15 bars
ECKN040500	kit of 5 nozzles, 5 l/h 15 bars
ECKN040000	kit of 1 nozzle, 5 l/h 15 bars
ECKN0305D0	kit of 50 nozzles, 4 l/h 15 bars
ECKN0301D0	kit of 10 nozzles, 4 l/h 15 bars
ECKN030500	kit of 5 nozzles, 4 l/h 15 bars
ECKN030000	kit of 1 nozzle, 4 l/h 15 bars
ECKN0205D0	kit of 50 nozzles, 2.5 l/h 15 bars
ECKN0201D0	kit of 10 nozzles, 2.5 l/h 15 bars
ECKN020500	kit of 5 nozzles, 2.5 l/h 15 bars
ECKN020000	kit of 1 nozzle, 2.5 l/h 15 bars
ACKRDM0000	direct automatic fitting R1/2"m pipe d.20
ACKRN01000	direct nipple m/m from G1/2"
ECKMOR1350	single clamp for pipe d.35
ECKMOR2350	double clamp for pipe d.35

Tab. 12.b

CAREL

